



EN

FM/AM CD Player      FM/AM CD Receiver  
**CDA-7995/CDA-7894**

**MP3 MX****(( ( XM )) )  
READY**

FR

FM/AM CD Receiver  
**CDA-7893/CDA-7892**

**MX****(( ( XM )) )  
READY**

ES

- OWNER'S MANUAL  
Please read before using this equipment.
- MODE D'EMPLOI  
Veuillez lire avant d'utiliser cet appareil.
- MANUAL DE OPERACIÓN  
Léalo antes de utilizar este equipo.

**ALPINE ELECTRONICS, INC.**  
Tokyo office: 1-1-8 Nishi Gotanda,  
Shinagawa-ku,  
Tokyo 141-8501, Japan  
Tel.: (03) 3494-1101

**ALPINE ELECTRONICS OF AMERICA, INC.**  
19145 Gramercy Place, Torrance,  
California 90501, U.S.A.  
Tel.: 1-800-ALPINE-1 (1-800-257-4631)

**ALPINE ELECTRONICS OF CANADA, INC.**  
Suite 203, 7300 Warden Ave. Markham,  
Ontario L3R 9Z6, Canada  
Tel.: 1-800-ALPINE-1 (1-800-257-4631)

**ALPINE ELECTRONICS OF AUSTRALIA PTY. LTD.**  
6-8 Fiveways Boulevard Keysborough,  
Victoria 3173, Australia  
Tel.: (03) 9769-0000

**ALPINE ELECTRONICS GmbH**  
Kreuzerkamp 7-11 40878 Ratingen, Germany  
Tel.: 02102-45 50

**ALPINE ITALIA S.p.A.**  
Via C. Colombo 8, 20090 Trezzano Sul Naviglio  
MI, Italy  
Tel.: 02-48 47 81

**ALPINE ELECTRONICS FRANCE S.A.R.L.**  
(RCS PONTOISE B 338 101 280)  
98, Rue De La Belle Etoile, Z.I. Paris Nord II  
B.P. 50016 F-95945, Roissy, Charles De Gaulle  
Cedex, France  
Tel.: 01-48 63 89 89

**ALPINE ELECTRONICS OF U.K., LTD.**  
13 Tanners Drive, Blakelands, Milton Keynes  
MK14 5BU, U.K.  
Tel.: 01908-61 15 56

**ALPINE ELECTRONICS DE ESPAÑA, S.A.**  
Portal De Gamarra 36, Pabellón 32  
01013 Vitoria (Alava)-Apdo. 133, Spain  
Tel.: 34-45-283588

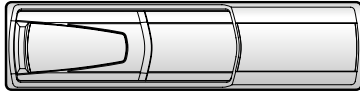

#### **CHA-S634**

- CD changer for CDA-7995/CDA-7894/CDA-7893/CDA-7892.
- Changeur CD pour CDA-7995/CDA-7894/CDA-7893/CDA-7892.
- Cambiador de CD para CDA-7995/CDA-7894/CDA-7893/CDA-7892.

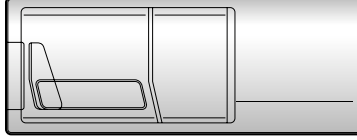

#### **CHA-1214**

- CD changer for CDA-7995/CDA-7894/CDA-7893/CDA-7892.
- Changeur CD pour CDA-7995/CDA-7894/CDA-7893/CDA-7892.
- Cambiador de CD para CDA-7995/CDA-7894/CDA-7893/CDA-7892.

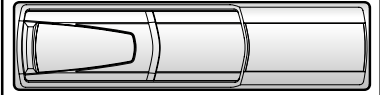

#### **CHM-S630**

## **Alpine CD Changers Give You More!**

***More musical selections, more versatility, more convenience.***

The CHA-S634 is a high-performance 6-disc changer with a new M DAC, CD-R/RW PLAY BACK, MP3 PLAY BACK and CD TEXT. The CHA-1214 Ai-NET model holds 12 discs, and the CHM-S630 M-Bus model is a super-compact 6-disc changer with a CD-R/RW PLAY BACK.

## **Changeurs de CD Alpine : vous avez le choix!**

***Plus de sélections musicales, plus de souplesse, plus de confort.***

Le modèle CHA-S634 est un changeur 6 disques ultra performant équipé des nouvelles fonctions M DAC, CD-R/RW PLAY BACK, MP3 PLAY BACK et CD TEXT. Le modèle CHA-1214 Ai-NET contient 12 disques. Le modèle CHM-S630 M-Bus est un changeur 6 disques super compact doté de la fonction CD-R/RW PLAY BACK.

## **¡Los cambiadores Alpine de CD le ofrecen más!**

***Más selecciones musicales, más versatilidad y más ventajas.***

CHA-S634 es un cambiador de seis discos de alto rendimiento con nuevo M DAC, CD-R/RW PLAY BACK, MP3 PLAY BACK y CD TEXT. El modelo CHA-1214 Ai-NET alberga 12 discos y el modelo CHM-S630 M-Bus es un cambiador de seis discos de tamaño reducido con un CD-R/RW PLAY BACK.

# Contents

## Operating Instructions



### WARNING

<b>WARNING</b> .....	<b>3</b>
<b>CAUTION</b> .....	<b>3</b>
<b>PRECAUTIONS</b> .....	<b>3</b>



### Basic Operation

Detaching the Front Panel .....	5
Attaching the Front Panel .....	5
Initial System Start-Up .....	5
Turning Power On and Off .....	5
Display Angle Adjustment .....	5
Adjusting Volume/Balance (Between Left and Right)/Fader (Between Front and Rear)/Defeat .....	6
Audio Mute Function .....	6
Displaying Time .....	6
Setting Time .....	6
Setting the Bass Control .....	7
Setting the Treble Control .....	7
Adjusting the built-in Crossover .....	7
About the Time Correction .....	8
Bass Focus .....	9
Time Correction .....	10
Setting the MX Mode .....	10
Quick Searching Function .....	11
Blackout Mode On and Off (CDA-7995/CDA-7894 only) .....	11
Changing the Audio Level Display Pattern .....	11
Displaying the Title/Text .....	12
Titling Discs/Stations .....	13
Erasing Disc Title/Station Title .....	13

## SETUP Operation

Switching the Tuner Mode .....	14
Changing Lighting Color (CDA-7894 only) ...	14
Dimmer Control (CDA-7995/CDA-7894/CDA-7893 only) .....	14
Subwoofer On and Off .....	14
Sound (Beep) Guide Function .....	15
Turning Mute Mode On/Off .....	15
Scroll Setting .....	15
Setting the AUX Mode (V-Link) .....	15
Connecting to an External Amplifier (CDA-7894/CDA-7893/CDA-7892 Only) ..	16
Setting the Defeat of the External Input .....	16
Demonstration .....	17
Adjusting Display Contrast (CDA-7995 only) .....	17

## Radio Operation

Manual Tuning .....	18
Automatic Seek Tuning .....	18
Manual Storing of Station Presets .....	18
Automatic Memory of Station Presets .....	19
Tuning to Preset Stations .....	19

## CD Player Operation

Opening and Closing the Movable display .....	20
Playback .....	20
Music Sensor (Skip) .....	21
Fast Forward and Backward .....	21
Repeat Play .....	21
M.I.X. (Random Play) .....	22
Scanning Programs .....	22
Controlling CD Changer (Optional) .....	22
Multi-Changer Selection .....	23

## MP3 Operation

Playing MP3 Files (CDA-7995/ CDA-7894 only) .....	24
Playing MP3 Files with the CD Changer (Optional) .....	24
Music Sensor (Skip) .....	24
Fast Forward and Backward .....	25
Selecting Folders .....	25
File Search .....	25
Repeat Play .....	25
M.I.X. (Random Play) .....	25
Scanning Programs .....	25
Setting the Range of MP3 File Selection .....	26
Playing MP3 Data .....	26
About MP3 .....	26

## XM Radio Operation

Receiving XM Channels with the XM Receiver (Optional) .....	28
Checking the XM Radio ID Number .....	28
Storing XM Channel Presets .....	29
Receiving Stored XM Channels .....	29
Category Search .....	29
Changing the Display .....	29

## Remote Control Operation

Controls on Remote Control .....	30
Battery Replacement .....	31

## Information

In Case of Difficulty .....	32
Specifications .....	35

---

## Installation and Connections

Warning .....	36
Caution .....	36
Precautions .....	36
Installation .....	37
Connections .....	38

## LIMITED WARRANTY

# **WARNING**

## **WARNING**

This symbol means important instructions. Failure to heed them can result in serious injury or death.

### **DO NOT OPERATE ANY FUNCTION THAT TAKES YOUR ATTENTION AWAY FROM SAFELY DRIVING YOUR VEHICLE.**

Any function that requires your prolonged attention should only be performed after coming to a complete stop. Always stop the vehicle in a safe location before performing these functions. Failure to do so may result in an accident.

### **KEEP THE VOLUME AT A LEVEL WHERE YOU CAN STILL HEAR OUTSIDE NOISE WHILE DRIVING.**

Failure to do so may result in an accident.

### **MINIMIZE DISPLAY VIEWING WHILE DRIVING.**

Viewing the display may distract the driver from looking ahead of the vehicle and cause an accident.

### **DO NOT DISASSEMBLE OR ALTER.**

Doing so may result in an accident, fire or electric shock.

### **USE ONLY IN CARS WITH A 12 VOLT NEGATIVE GROUND.**

(Check with your dealer if you are not sure.) Failure to do so may result in fire, etc.

### **KEEP SMALL OBJECTS SUCH AS BATTERIES OUT OF THE REACH OF CHILDREN.**

Swallowing them may result in serious injury. If swallowed, consult a physician immediately.

### **USE THE CORRECT AMPERE RATING WHEN REPLACING FUSES.**

Failure to do so may result in fire or electric shock.

### **DO NOT BLOCK VENTS OR RADIATOR PANELS.**

Doing so may cause heat to build up inside and may result in fire.

### **USE THIS PRODUCT FOR MOBILE 12V APPLICATIONS.**

Use for other than its designed application may result in fire, electric shock or other injury.

### **DO NOT PLACE HANDS, FINGERS OR FOREIGN OBJECTS IN INSERTION SLOTS OR GAPS.**

Doing so may result in personal injury or damage to the product.

## **CAUTION**

This symbol means important instructions. Failure to heed them can result in injury or material property damage.

### **HALT USE IMMEDIATELY IF A PROBLEM APPEARS.**

Failure to do so may cause personal injury or damage to the product. Return it to your authorized Alpine dealer or the nearest Alpine Service Center for repairing.

### **DO NOT MIX NEW BATTERIES WITH OLD BATTERIES. INSERT WITH THE CORRECT BATTERY POLARITY.**

When inserting the batteries, be sure to observe proper polarity (+ and -) as instructed. Rupture or chemical leakage from the battery may cause fire or personal injury.

### **KEEP FINGERS AWAY WHILE THE MOTORIZED FRONT PANEL OR MOVING MONITOR IS IN MOTION.**

Failure to do so may result in personal injury or damage to the product.

## **PRECAUTIONS**

### **Temperature**

Be sure the temperature inside the vehicle is between +60°C (+140°F) and -10°C (+14°F) before turning your unit on.

### **Moisture Condensation**

You may notice the CD playback sound wavering due to condensation. If this happens, remove the disc from the player and wait about an hour for the moisture to evaporate.

### **Damaged Disc**

Do not attempt to play cracked, warped, or damaged discs. Playing a bad disc could severely damage the playback mechanism.

### **Maintenance**

If you have problems, do not attempt to repair the unit yourself. Return it to your Alpine dealer or the nearest Alpine Service Station for servicing.

# ⚠ WARNING

## ⚠ PRECAUTIONS

### Never Attempt the Following

Do not grip or pull out the disc while it is being pulled back into the player by the automatic reloading mechanism.

Do not attempt to insert a disc into the unit when the unit power is off.

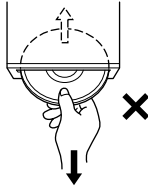

### Inserting Discs

Your player accepts only one disc at a time for playback. Do not attempt to load more than one disc.

Make sure the label side is facing up when you insert the disc. Your player will automatically eject any disc that is inserted incorrectly. If the player continues to eject a correctly inserted disc, push the RESET switch with a pointed object such as a ballpoint pen.

Playing a disc while driving on a very bumpy road may result in skips, but this will not scratch the disc or damage the player.

### New Discs

As a protective measure to prevent the CD from jamming, the CD player will automatically eject discs with irregular surfaces or inserted incorrectly. When a new disc is inserted into the player and ejected after initial loading, using your finger, feel around the inside of the centre hole and outside edge of the disc. If you feel any small bumps or irregularities, this could inhibit proper loading of the disc. To remove the bumps, rub the inside edge of the hole and outside edge of the disc with a ballpoint pen or other such instrument, then insert the disc again.

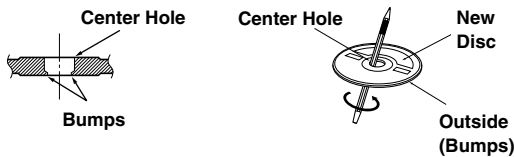

### Irregular Shaped Discs

Be sure to use round shape discs only for this unit and never use any special shape discs.

Use of special shape discs may cause damage to the mechanism.



### Installation Location

Make sure the CDA-7995/CDA-7894/CDA-7893/CDA-7892 will not be installed in a location subjected to:

- Direct sun and heat
- High humidity and water
- Excessive dust
- Excessive vibrations

### Correct Handling

Do not drop the disc while handling. Hold the disc so you will not leave fingerprints on the surface. Do not affix tape, paper, or gummed labels to the disc. Do not write on the disc.

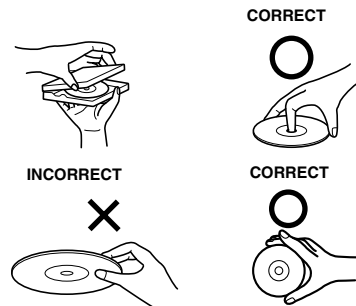

### Disc Cleaning

Fingerprints, dust, or soil on the surface of the disc could cause the CD player to skip. For routine cleaning, wipe the playing surface with a clean, soft cloth from the centre of the disc to the outer edge. If the surface is heavily soiled, dampen a clean, soft cloth in a solution of mild neutral detergent before cleaning the disc.



### Disc Accessories

There are various accessories available on the market for protecting the disc surface and improving sound quality. However, most of them will influence the thickness and/or diameter of the disc. Using such accessories can cause the disc to be out of standard specifications and may create operational problems. We recommend not using these accessories on discs played in Alpine CD players.

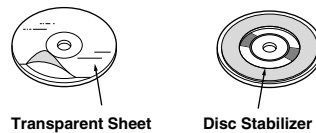

# Basic Operation

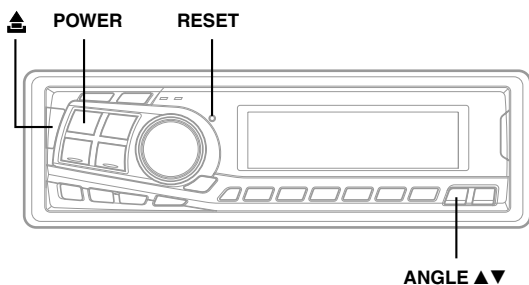

## Detaching the Front Panel

- 1 Press and hold the **POWER** button for more than 3 seconds to turn off the power.
- 2 Press the  (Release) button at upper left side until the front panel pops out.
- 3 Grasp the left side of the front panel and pull it out.

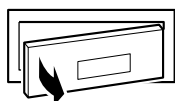

### NOTES

- The front panel may become hot in normal usage (especially the connector terminals on the back of the front panel.) This is not a malfunction.
- To protect the front panel, place it in the supplied carrying case.

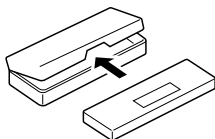

## Attaching the Front Panel

- 1 First, insert the right side of the front panel into the main unit. Align the groove on the front panel with the projections on the main unit.
- 2 Push the left side of the front panel until it locks firmly into the main unit.

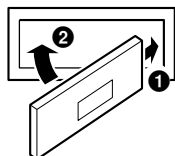

### NOTES

- Before attaching the front panel, make sure that there is no dirt or dust on the connector terminals and no foreign object between the front panel and the main unit.
- Attaching the front panel carefully, holding the sides of the front panel to avoid pushing buttons by mistake.

## Initial System Start-Up

Be sure to press the **RESET** switch when using the unit for the first time, after installing the CD changer, etc., or after changing the car battery.

- 1 Make sure that the power of the unit is off. If the power is on, press and hold the **POWER** button for at least 3 seconds to turn off the unit.
- 2 Press the **RESET** switch with a ballpoint pen, or any other pointed object.



## Turning Power On and Off

- 1 Press the **POWER** button to turn on the unit.

### NOTE

The unit can be turned on by pressing any other button except the eject  and CLK/TITLE button.

The volume level gradually increases to the previous level you were listening to before the unit was turned off. Press and hold the **POWER** button for at least 3 seconds to turn off the unit.

### NOTE

The first time power is turned on, the volume will start from level 12.

## Display Angle Adjustment

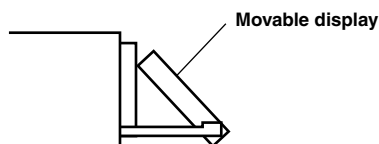

The movable display may be adjusted to 3 different angles depending upon user preference.

- 1 Press the **ANGLE ▲▼** button to adjust the angle of the movable display.

### NOTES

- The display will close a half minute after the ignition key is turned to the OFF position.
- The adjusted angle of the display is stored in memory. There is no need to re-adjust the angle when the power is turned back on.

### CAUTION

Keep hands (or any other object) away from the display while it is opening or closing to avoid damage or injury. The back of the movable display will get very warm under normal operating conditions. This is not a malfunction. Do not touch.

# Basic Operation

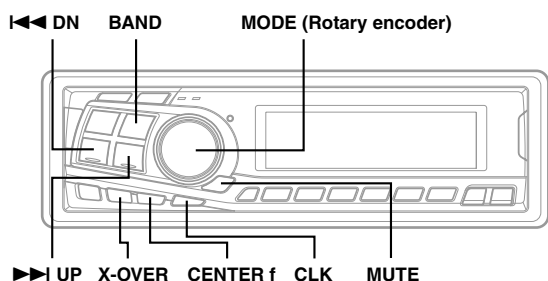

## Adjusting Volume/Balance (Between Left and Right)/Fader (Between Front and Rear)/Defeat

- 1 Press the **MODE (Rotary encoder)** button repeatedly to choose the desired mode.

Each press changes the modes as follows:

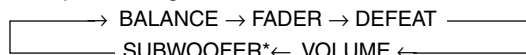

Volume : 0 ~ 35

Balance : L15 ~ R15

Fader: R15 ~ F15

Subwoofer: 0 ~ +15

### NOTES

- If the **MODE** button is not pressed within 5 seconds after selecting the **BALANCE**, **FADER**, **DEFEAT** or **SUBWOOFER** mode, the unit automatically returns to the **VOLUME** mode.
- \*When the subwoofer mode is **OFF**, its level cannot be adjusted.

- 2 Turn the **Rotary encoder** until the desired sound is obtained in each mode.  
By setting Defeat ON, previously adjusted settings of **BASS**, **TREBLE** will return to the factory defaults, but **MX** will be turned off.

### NOTE

Depending on the connected devices, some functions and display indications do not work.

## Audio Mute Function

Activating this function will instantly lower the volume level by 20 dB.

- 1 Press the **MUTE** button to activate the **MUTE** mode.  
The audio level will decrease by about 20 dB.  
Pressing the **MUTE** button again will bring the audio back to its previous level.

## Displaying Time

- 1 Press the **CLK** (clock) button repeatedly until the time is displayed.

Each press changes the modes as follows:

### Radio mode

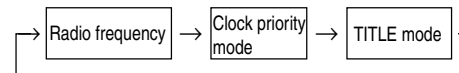

### CD Player/Changer modes

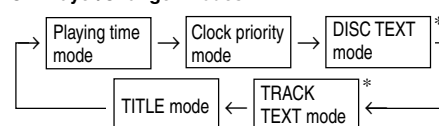

### NOTES

- Selecting any tuner or CD function while in the clock priority mode will interrupt the time display momentarily. The function selected will be displayed for about 5 seconds before the time returns to the display.
- When the power is off but the ignition key is on, press the **CLK** button to display the time.
- \*For CDA-7893/CDA-7892 models, the display above is shown with a CD-TEXT compatible changer connected.

## Setting Time

- 1 In the Clock priority mode, press and hold the **CLK** (clock) button for at least 3 seconds while the time is displayed. The time indication will blink.
- 2 Turn the **Rotary encoder** to adjust the hours while the time indication is blinking.
- 3 When the hour has been adjusted, press the **Rotary encoder**.
- 4 Turn the **Rotary encoder** to adjust the minutes while the time indication is blinking. The time is automatically set 5 seconds after the minute adjustment. The time can also be manually set by pressing the **Rotary encoder**.



## Setting the Bass Control

You can change the Bass Frequency emphasis to create your own tonal preference.

- 1 Press the **CENTER f** button to select the BASS (bass Center frequency) control mode.

→ BASS → TREBLE → normal mode →

- 2-1 Setting the bass Center frequency:

Press the **◀◀ DN** or **▶▶ UP** button to select the desired bass center frequency.

→ 60Hz ↔ 70Hz ↔ 80Hz ↔ 90Hz ←  
→ 180Hz ↔ 150Hz ↔ 130Hz ↔ 100Hz ←

Emphasizes the displayed Bass frequency ranges.

- 2-2 Setting the bass Band Width (Q-Factor):

Press the **BAND** button to select the desired bass Band Width.

→ B. Width1 → B. Width2 → B. Width3 → B. Width4  
(Wide) ←.....→ (Narrow)

Changes the bass boost band width to wide or narrow. A wide setting will boost a wide range of frequencies above and below the center frequency. A narrower setting will boost only frequencies near the center frequency.

- 2-3 Setting the bass Level:

Turn the **Rotary encoder** to select the desired bass Level (-7~+7).

You can emphasize or weaken the bass frequency.

### NOTES

- If no buttons are pressed within 5 seconds, the Bass control setting will be turned off automatically.
- The settings of the Bass Level will be individually memorized for each source (FM, AM, XM, CD, etc.) until the setting is changed. Once you set Bass frequency and Bass Band Width for one of sources (FM, AM, XM, CD, etc.), this setting becomes effective for all those sources. Depending on the connected devices, some functions and display indications do not work.
- This function is inoperable when DEFEAT is ON.

## Setting the Treble Control

You can change the Treble Frequency emphasis to create your own tonal preference.

- 1 Press the **CENTER f** button to select the TREBLE (treble Center frequency) control mode.

→ BASS → TREBLE → normal mode →

- 2-1 Setting the treble Center frequency:

Press **◀◀ DN** or **▶▶ UP** button to select the desired treble Center frequency.

→ 10.0kHz ↔ 12.5kHz ↔ 15.0kHz ↔ 17.5kHz ←

Emphasizes the displayed Treble frequency ranges.

- 2-2 Setting the treble Level:

Turn the **Rotary encoder** to select the desired Treble Level (-7~+7).

You can emphasize the treble frequency.

### NOTES

- If no buttons are pressed within 5 seconds, the Treble control setting will be turned off automatically.
- The settings of the Treble Level will be individually memorized for each source (FM, AM, XM, CD, etc.) until the setting is changed. Once you set Treble frequency for one of sources (FM, AM, XM, CD, etc.), this setting becomes effective for all those sources. Depending on the connected devices, some functions and display indications do not work.
- This function is inoperable when DEFEAT is ON.

## Adjusting the built-in Crossover

The High and Low Pass Filters on this unit can be adjusted to suit your personal taste.

- 1 Press and hold the **X-OVER** button for at least 2 seconds.

Repeat this procedure to select the desired parameter.

→ HPF → LPF\* → normal mode →

\* When the subwoofer output of this unit is turned OFF, LPF and phase are deactivated.

- 2 Press the **◀◀ DN** or **▶▶ UP** button to select the desired setting.

1. HPF (Setting the High Pass Filter):

FLAT (OFF) ↔ 80Hz ↔ 120Hz ↔ 160Hz

Outputs all frequencies higher than that selected according to your preference.

2. LPF (Setting the Low Pass Filter):

FLAT (OFF) ↔ 80Hz ↔ 120Hz ↔ 160Hz

Outputs all frequencies lower than that selected according to your preference.

(Only available when using the subwoofer output from this unit.)

### NOTES

- If no buttons are pressed within 5 seconds, the setup menu returns to the normal audio display.
- These functions are inoperative when an external, Ai-NET processor is connected.
- If HPF, LPF, Bass Control and Treble Control are all set to ON, depending on the Bass Control and Treble Control settings, you may not be able to reinforce the sound effect.
- Except when the HPF and LPF is turned OFF, the subwoofer is in monaural mode.
- When the subwoofer is set to OFF, LPF mode and change of phase does not work.

# Basic Operation

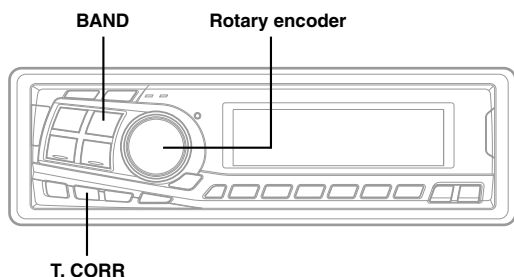

Here we calculate the time correction value for the front left speaker in the diagram at the left.

Conditions:

Farthest Speaker – listening position : 2.25 m (88-9/16")

Front left speaker – listening position : 0.5 m (19-11/16")

Calculation:  $L = 2.25 \text{ m} - 0.5 \text{ m} = 1.75 \text{ m} (68-7/8")$

Time correction =  $1.75 \div 343^* \times 1000 = 5.1 \text{ (ms)}$

\*Speed of sound: 343 m/s (765 mph) at 20°C

In other words, giving the front left speaker a time correction value of 5.1 ms makes it seem as if the distance to the front left speaker is the same as the distance to the farthest speaker.

The sound is not balanced because the distance between the listening position and the various speakers is different. The difference in distance between the front left speaker and the rear right speaker is 1.75 m (68-7/8").

Time correction eliminates the differences in the time required for the sound to reach the listening position. The time of the front left speaker is corrected by 5.1 ms so that its sound reaches the listening position at the same time as the sound of other speakers.

## About the Time Correction

The distance between the listener and the speakers in a car vary widely due to the special conditions of the mobile environment. This difference in the distances from the speakers to the listener creates a shift in the sounds image and frequency characteristics. This is caused by the time delay between the sound reaching the listener's right versus the left ear.

To correct this, the CDA-7995/CDA-7894/CDA-7893/CDA-7892 is able to delay the audio signal to the speakers closest to the listener. This effectively creates a perception of increased distance for those speakers. The listener can be placed at an equal distance between the left and right speakers for optimum staging.

The adjustment will be made for each speaker in a step of 0.1 ms.

### Example 1. Listening Position: Front Left Seat

Adjust the time correction level of the front left speaker to a high value and the rear right to zero or a low value.

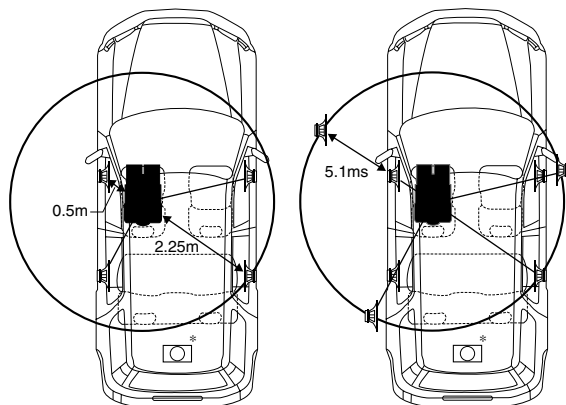

### Tips

\* Subwoofer speaker.

You cannot change the Time Correction value for the subwoofer, but you can set the subwoofer's apparent position to the front by adjusting the Time Correction value of the front and rear speakers.

For details, refer to the "Tips" on page 9.

### Example 2. Listening Position: All Seats

Adjust the time correction level of each speaker to almost the same level.

- 1 Sit in the listening position (driver's seat, etc.) and measure the distance (in meters) between your head and the various speakers.
- 2 Calculate the difference between the distance to the farthest speaker and the other speakers.  
 $L = (\text{distance to farthest speaker}) - (\text{distance to other speakers})$
- 3 Divide the distances calculated for the speakers by the speed of sound (343 m/s (765 mph) at 20°C). These values are the time correction values for the different speakers.

## Bass Focus

The time difference between the front-rear/left-right speakers, can be adjusted at the same time. With an initial delay of 0.3 ms for each of the 0 to 39 steps, audible time correction can be done. For finer adjustment, use the procedure in the previous section "Time Correction," for which the delay steps are 0.1 ms.

- 1 Press the **T.CORR** button to select the Bass Focus mode.

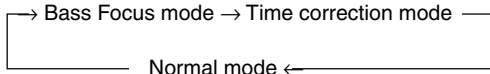

- 2 Press the **BAND** button to select the front-rear / left-right speakers.

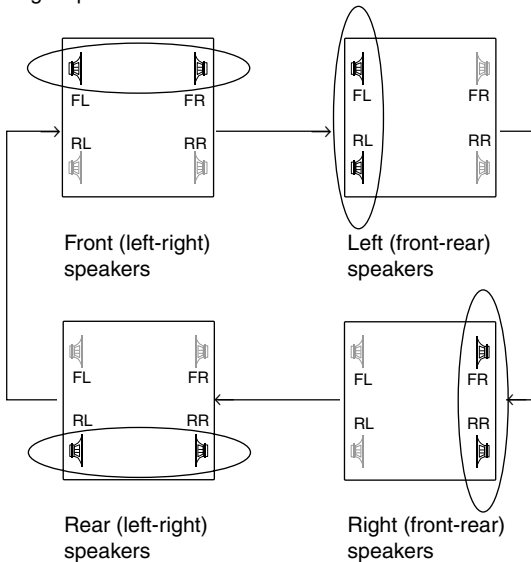

- 3 Turn the **Rotary encoder** to adjust the front-rear / left-right delay.
- 4 For setting another channel (speaker), repeat the steps 2 and 3.
- 5 After setting, press the **T.CORR** to return to the normal mode.

### NOTES

- Any manual time correction adjustments will also affect corrections made in Bass Focus. However, since the interval of the manual mode is 0.1ms and that of Bass Focus is 1 step (0.3ms), some difference may occur.
- Time Correction mode is automatically canceled if no buttons are pressed within 15 seconds.

### Example of Steps 2 and 3 Setting

- (1) After entering corrections for the front (left and right) speakers in STEP 5, the time difference is 1.5 ms for both front-left and front-right speakers.

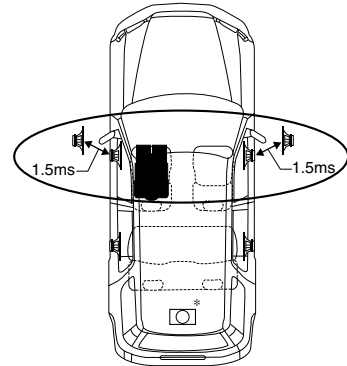

- (2) After entering corrections for the left (front and rear) speakers in STEP 5, the time difference becomes 3.0 ms\* for the front left speaker and 1.5 ms for the left rear speaker.

\* Because the time difference was already set to 1.5 ms for the front left speaker in STEP 1, the additional correction in STEP 5 makes the time difference of the front left speaker 3.0 ms.

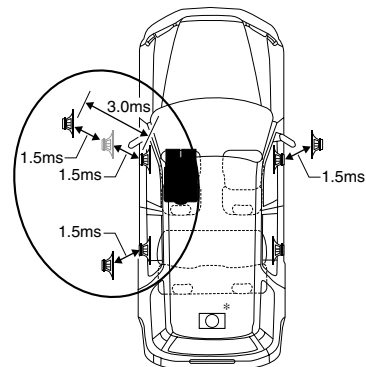

### Tips

\* Subwoofer speaker.

Delay (turn the rotary encoder) the audio signal to the front (left and right) speakers to make the apparent position of the subwoofer to be at the front. In doing this, the apparent position between the front (left and right) speakers and subwoofer will appear equal to the driver. After performing above, you can change the positions of left and right speakers by delaying the time .

Continued

# Basic Operation

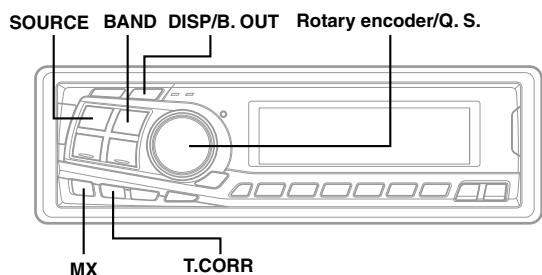

Time Difference Table

Number of Steps	Time Difference (ms)	Number of Steps	Time Difference (ms)	Number of Steps	Time Difference (ms)
0	0.0	14	4.2	28	8.4
1	0.3	15	4.5	29	8.7
2	0.6	16	4.8	30	9.0
3	0.9	17	5.1	31	9.3
4	1.2	18	5.4	32	9.6
5	1.5	19	5.7	33	9.9
6	1.8	20	6.0	34	10.2
7	2.1	21	6.3	35	10.5
8	2.4	22	6.6	36	10.8
9	2.7	23	6.9	37	11.1
10	3.0	24	7.2	38	11.4
11	3.3	25	7.5	39	11.6
12	3.6	26	7.8		
13	3.9	27	8.1		

## Time Correction

Before performing the following procedures, refer to "About the Time Correction" (page 8).

- 1 Make time corrections by pressing the **T.CORR** button.

Each press changes the modes as follows:

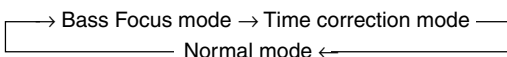

- 2 Select a speaker to be adjusted by pressing the **BAND** button.

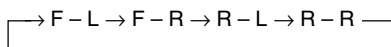

- 3 Adjust the desired time correction value by turning the **Rotary encoder**.
- 4 For setting another speaker, repeat the step 2 and 3.
- 5 After setting, press the **Rotary encoder** to return to the normal mode.

### NOTE

Time Correction mode is automatically canceled if no buttons are pressed within 15 seconds.

## Setting the MX Mode

MX (Media Xpander) makes vocals or instruments sound distinct regardless of the music source. The radio, CD, and MP3, will be able to reproduce the music clearly even in cars with a lot of road noise.

- 1 Press the **MX** button to select MX ON.
- 2 Press the **SOURCE** button to select the source you want to MX (Media Xpander)-correct.
- 3 Press and hold the **MX** button for at least 2 seconds to select the MX mode.
- 4 Turn the **Rotary encoder** to select your preferred mode or OFF (NON EFFECT).

### FM (MX level 1 to 3):

The medium to high frequencies become more clear, and produces well balanced sound in all the bands.

### CD (MX level 1 to 3):

CD mode processes a large quantity of data. This data is used to reproduce the sound cleanly by making use of the data quantity.

### MP3/XM (MX level 1 to 3):

This corrects information that was omitted at the time of compression. This reproduces a well-balanced sound close to the original.

### DVD (Video CD) (MX level 1 to 2):

The dialog portion of the video is reproduced more clearly.

### DVD (CD) (MX level 1):

This disk contains a large quantity of data such as music clip. MX uses this data to reproduce the sound accurately.

### AUX (MX level 1):

Choose the MX mode (MP3, MUSIC, or MOVIE) that corresponds to the media connected.

- 5 After setting, press the **Rotary encoder** to return to the normal mode.

### NOTES

- By "Setting the Defeat of the external input" (page 16) to ON, operation is bypassed.
- To cancel MX mode for all music sources, press the MX button to turn MX off.
- MX mode is automatically canceled if no buttons are pressed within 15 seconds.
- Each music source, such as radio, CD, and MP3 can have its own MX setting.
- On disks with both MP3 and CD-DA, when the source changes from "MP3 to CD-DA" or "CD-DA to MP3", the MX-mode switching process may take a little time before a piece is played due to.
- Setting to MX OFF makes MX mode of each music source OFF.
- This function is inoperable when DEFEAT is ON.

## Quick Searching Function

You can easily select tracks and files.

- 1 Press the **SOURCE** button to set the desired source mode.  
( CD mode is explained here as an example)
- 2 When setting the CD mode, press and hold the **Q.S.** button for at least 2 seconds. The mode changes to the Q.S. (Quick Search) setting.
- 3 Select a desired track by turning the **Rotary encoder** to the right or left.
  - CD/Changer mode: Track can be selected.
  - XM mode: Channel can be selected. (It is not possible to select in the tuner mode)
  - MP3 mode: File number can be selected.
- 4 When the setting is completed, the Q.S. mode is canceled by pressing the **Rotary encoder**.

### NOTES

*The Q.S. mode is automatically canceled after 10 seconds if no buttons are pressed during step 2 and 3.*

## Blackout Mode On and Off (CDA-7995/CDA-7894 only)

When the Blackout mode is turned on, the display will turn off to reduce power consumption.  
This additional power enhances the sound quality.

- 1 Press and hold the **B.OUT** button for at least 3 seconds to start the blackout mode. By doing so the display will turn off.

### NOTE

*If any button on the unit is pressed during the blackout mode, the function will be displayed for 5 seconds to show the operation before returning to Blackout mode.*

To cancel the blackout mode, press and hold the **B.OUT** button for at least 3 seconds.

## Changing the Audio Level Display Pattern

You can select the Audio Level Display from three display patterns (For the CDA-7892 model, only pattern 1 is displayed). You can also deactivate the display.

- 1 Press **DISP** button to switch the display pattern.

CDA-7995/CDA-7894/CDA-7893:

→ Pattern1 → Pattern2 → Pattern3 → OFF

CDA-7892:

Pattern display ↔ OFF

# Basic Operation

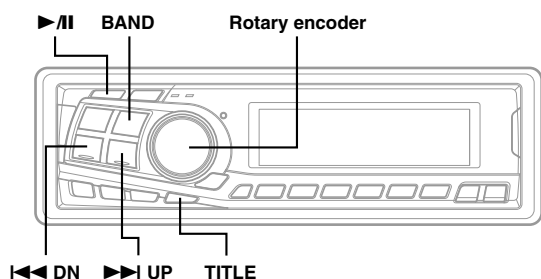

MP3 mode: (MP3 files can be played back with the CDA-7893/CDA-7892 models if an MP3 compatible changer is connected.)

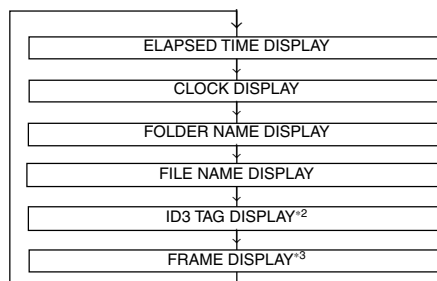

## Displaying the Title/Text

It is possible to display the CD/Station title if the title has been previously inputted. For details, see "Tilting Disc/Stations" (page 13). Text information, such as the disc name and the track name, will be displayed if playing a CD text compatible disc. It is also possible to display the folder name, the file name, and the ID3 tag, etc. while playing MP3 files.

- 1 Press the **TITLE** button.  
The mode will change every time the button is pressed.

### About "Title" and "Text"

**Title:** With this device, it is possible to input the CD/Station name (refer to page 13). This inputted name is referred to as a "title."

You cannot input or display titles on MP3 discs.

**Text:** Text compatible CDs contain text information such as the disc name and track name. Such text information is referred to as "text."

Radio mode:

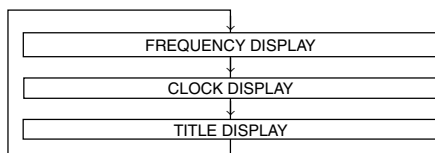

CD mode: (Text is displayed for the CDA-7893/CDA-7892 models when a compatible changer with CD text is connected.)

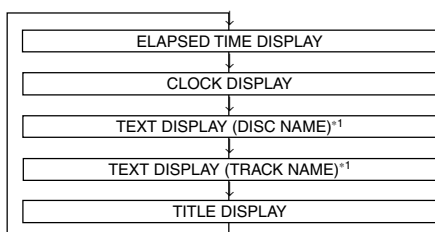

- \*1 Displayed during playback of a disc with CD Text. "NO TEXT" will be displayed when the CD contains no Text data.  
Text cannot be displayed for the CDA-7893/CDA-7892 models.
- \*2 If an MP3 file contains ID3 tag information, all the ID3 tag information is displayed (e.g., track name, artist name, and album name). All other tag data is ignored.  
"NO TAG" will be displayed when an MP3 file contains no ID3 tag information.
- \*3 The recording sampling rate and bit rate of the MP3 file are displayed.

### NOTES

- Some characters may not be displayed correctly with this device, depending on the character type.
- The CD changer must also be CD Text compatible for the Text information to be displayed.
- When the Scroll Setting (refer to page 15) is set to "SCROLL MANUAL", press and hold the TITLE button for at least 3 seconds to scroll the Text information only once (TEXT DISPLAY, FOLDER NAME DISPLAY, FILE NAME DISPLAY or ID3 TAG DISPLAY mode).
- "NO SUPPORT" (CDA-7892: "NO SUPRT") is displayed when the desired text information cannot be displayed on this unit.
- If the title was not previously input, "NO TITLE" is displayed.



## Titling Discs/Stations

It is possible to title your favorite CD's or radio stations. You cannot input titles on MP3 discs (Except when a changer is connected).

- 1 Press the **TITLE** button and select the title display mode.  
For details, see "Displaying the Title/Text" (page 12).
- 2 Press and hold the **TITLE** button for at least 3 seconds. The first character will blink.  
CDA-7995 only:  
Press the **BAND** button to select the characters/symbols.
- 3 Turn the **Rotary encoder** to select the desired letter/numeral/symbol available for naming.
- 4 Press the **Rotary encoder** to store the first character. The first character will stop blinking and the display will automatically advance to the next character. When that character begins to blink, you may choose the next letter or symbol of your title.
- 5 Repeat the steps 3 and 4 above to complete the titling. Pressing the **Rotary encoder** after entering the 8th character, automatically stores the title into memory.  
When entering a title of less than 8 characters (for example, 3 character title):  
After entering 3 characters to complete your title, the 4th character space will be blinking. Go to step 6 to complete the title.

- 6 Press the **TITLE** button to record the title.

### NOTES

- You can enter 24 radio station titles and 18 CD titles on this unit. If you try to store beyond the limit, the display will show "FULL DATA." At this point, no more titles can be stored.
- The CD Changer title length or memory capacity varies depending upon the model being used.
- To input a new title, one of the previously inputted titles must first be deleted.
- When you want to erase a title, enter the "  ", "  " (CDA-7995 only) symbol into all spaces.
- The operations described in steps 3 to 5 must be made within 10 seconds. The input mode will be cancelled if no action is taken for over 10 seconds.
- Removing power from the unit may delete these titles. Use caution when manipulating the power cord.

## Erasing Disc Title/Station Title

- 1 Press the **TITLE** button to select the titling mode. Then, press and hold for at least 3 seconds.
- 2 Press and hold the **▶/||** button for at least 2 seconds to activate the title scanning mode. The title in the display will blink.
- 3 Press the **◀◀ DN** or **▶▶ UP** button repeatedly until the title you want to erase is displayed.
- 4 Press and hold the **▶/||** button for at least 2 seconds to erase the title displayed.
- 5 Press the **TITLE** button to cancel the title erasing mode.

### NOTE

You cannot erase CD-TEXT.

# SETUP Operation

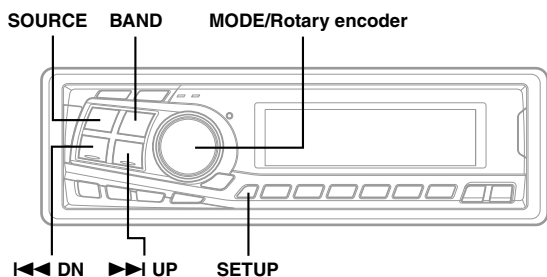

## Switching the Tuner Mode

The CDA-7995/CDA-7894/CDA-7893/CDA-7892 incorporates the MAX TUNE SQ for the highest quality tuner audio. Moreover, you can choose between two settings to suit your own personal sound preferences and usage.

- 1 Press and hold the **SETUP** button for at least 3 seconds.
- 2 Press the **>>= UP** or **<=< DN** button to select "NORMAL or HI-FI."
- 3 Press the **BAND** button to switch the TUNER mode.  
HI-FI ↔ NORMAL  
NORMAL: Standard setting  
HI-FI: Sound quality priority setting

### NOTES

- The initial setting at the factory is "NORMAL."
- If you find the sound is very noisy while listening to the tuner in the HI-FI mode, we recommend you change to the NORMAL mode.

- 4 When the setting is completed, press the **SETUP** button to return to the normal mode.

### NOTE

"MP3 File Selection" and "Playing MP3 data" in the "SETUP" mode section are described in MP3 Operation on page 26.

## Changing Lighting Color (CDA-7894 only)

- 1 Press and hold the **SETUP** button for at least 3 seconds.
- 2 Press the **>>= UP** or **<=< DN** button to select "AMBER".
- 3 Press the **BAND** button to toggle the mode between AMBER ON (amber) and AMBER OFF (green).
- 4 Press the **SETUP** button to set the selected mode.

## Dimmer Control (CDA-7995/CDA-7894/CDA-7893 only)

Set the DIMMER control to AUTO to decrease the illumination brightness of the unit with the head lights of the vehicle ON. This mode is useful if you feel the unit's backlighting is too bright at night.

- 1 Press and hold the **SETUP** button for at least 3 seconds.
- 2 Press the **>>= UP** or **<=< DN** button to select "DIM"(DIMMER).
- 3 Press the **BAND** button to select the Dimmer mode. Each press toggles between DIM AUTO and DIM MANUAL.
- 4 Press the **SETUP** button to activate the normal mode.

## Subwoofer On and Off

- 1 Press and hold the **SETUP** button for at least 3 seconds.
- 2 Press the **>>= UP** or **<=< DN** button to select "SUB (Subwoofer)."
- 3 Press the **BAND** button to toggle mode between SUB W ON and SUB-W OFF (CDA-7892: SUB W OFF).

### NOTE

The initial setting at the factory is subwoofer ON.

- 4 Press the **SETUP** button after setting the SUB-W ON.
- 5 Press the **MODE** button repeatedly to select the SUB-W mode.



Press the **<=< DN** or **>>= UP** button after selecting the SUB-W mode, and the subwoofer output phase is toggled SUBW NOR (0°) or SUBW REV (180°).

- 6 Turn **Rotary encoder** until the desired sound is obtained in each mode.



## Sound (Beep) Guide Function

This function will give audible feedback with varying tones depending upon the button pressed.

- 1 Press and hold the **SETUP** button for at least 3 seconds.
- 2 Press the **▶▶I UP** or **I◀◀ DN** button to select "BEEP"
- 3 Press the **BAND** button to toggle the mode between BEEP ON and BEEP OFF.

### NOTE

*The initial setting at the factory is BEEP ON.*

- 4 Press the **SETUP** button to set the selected mode.

## Turning Mute Mode On/Off

If a device having the interrupt feature is connected, audio will be automatically muted whenever the interrupt signal is received from the device. This function can be turned ON or OFF from the head unit by following procedure below.

- 1 Press and hold the **SETUP** button for at least 3 seconds.
- 2 Press the **▶▶I UP** or **I◀◀ DN** button to select the MUTE mode.
- 3 Press the **BAND** button to turn on or off the MUTE mode. Each press toggles between the MUTE ON and OFF modes.

### NOTE

*The initial setting at the factory is "MUTE ON."*

- 4 Press the **SETUP** button again to return to normal operation.

## Scroll Setting

This CD player can scroll the disc and track names recorded on CD-TEXT discs, as well as the text information of MP3 files, folder names, and ID3 tags. (This function can be used for CDA-7893/CDA-7892 models if the changer compatible with CD-Text is connected).

- 1 Press and hold the **SETUP** button for at least 3 seconds.
- 2 Press the **▶▶I UP** or **I◀◀ DN** button to select "SCR"(SCROLL).

- 3 Press the **BAND** button to toggle the mode between SCR AUTO and MANUAL (For CDA-7892 model: MANU is displayed).

- SCR AUTO: the CD text information, the text information of folder and file names, and the ID3 tags are scrolled automatically.
- SCR MANUAL: the display is scrolled only when a disc is loaded or when a track is changed, etc.

- 4 When the setting is completed, press the **SETUP** button to return to the normal mode.

### NOTES

- Initial mode is "SCR MANUAL."
- The unit scrolls CD text names, folder names, file names or ID3 tag display. The disc titles input manually (refer to page 13) cannot be scrolled.

## Setting the AUX Mode (V-Link)

You can input TV/video sound by connecting an optional Ai-NET/RCA Interface cable (KCA-121B) or Versatile Link Terminal (KCA-410C) to this component.

- 1 Press and hold the **SETUP** button for at least 3 seconds.
- 2 Press the **▶▶I UP** or **I◀◀ DN** button to select "AUX."
- 3 Press the **BAND** button to toggle the mode between AUX ON and AUX OFF.

### NOTES

- The initial setting at the factory is AUX OFF.
- You can set the AUX mode display by pressing the **I◀◀ DN** or **▶▶I UP** button after AUX ON is set, select the AUX mode display setting, and then press the **BAND** button.
- When connecting the KCA-410C, you can set two AUX mode displays.

- 4 Press the **SETUP** button to return to normal mode.

- 5 To adjust the volume, etc., first press the **SOURCE** button and select the AUX mode, then make the necessary adjustment.

### NOTE

*When using the Versatile Link Terminal (KCA-410C), you can connect two external inputs. To select the mode, press the **BAND** button on the unit.*

# SETUP Operation

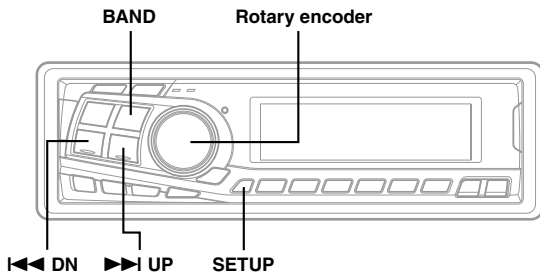

## Connecting to an External Amplifier (CDA-7894/CDA-7893/CDA-7892 only)

When an external amplifier is connected, sound quality can be improved by stopping the power supply of the built-in amplifier. The power output is set to OFF by the following procedure.

- 1 Press and hold the **SETUP** button for at least 3 seconds.
- 2 Press the **▶▶ UP** or **◀◀ DN** button to select "PWR-IC" (CDA-7892: "PWR").
- 3 Press the **BAND** button to toggle the mode between PWR-IC ON (CDA-7892: PWR ON) and PWR-IC OFF (CDA-7892: PWR OFF).

**PWR-IC OFF (CDA-7892: PWR OFF):**  
When activating the speakers, this setting can be performed by connecting between the front and rear pre-amplifier of the unit and the external amplifier. In this setting, nothing is output to the speakers.

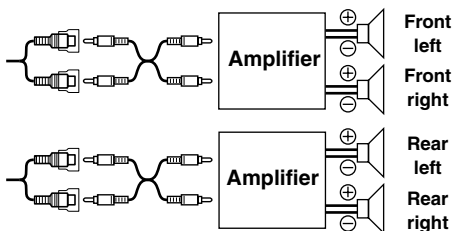

**PWR-IC ON (CDA-7892: PWR ON):**  
The speakers are driven by the built-in amplifier.

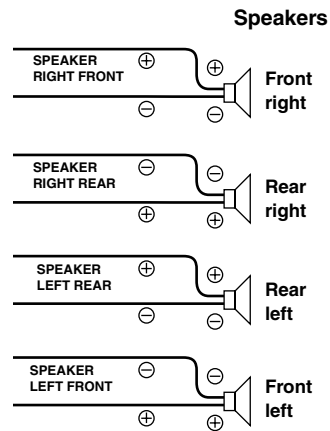

### NOTE

No sound is produced by the system when the power output is set to OFF

- 4 Press the **SETUP** button to return to normal mode.

## Setting the Defeat of the External Input

When auxiliary devices such as a TV or video game, etc., are used with this unit, you can use the audio function to set the mode between BASS, TREBLE and MX Defeat ON/OFF.

- 1 Press and hold the **SETUP** button for at least 3 seconds.
- 2 Press the **▶▶ UP** or **◀◀ DN** button to select "INT."
- 3 Press the **BAND** button to toggle the mode between INT ON and INT OFF.  
When using Initial mode, set this to ON.  
When the Initial mode is not selected, set this to OFF.
- 4 Press the **SETUP** button to return to normal mode.

## Demonstration

---

This unit has a Demonstration feature which simulates the display functions.

- 1 Press and hold the **SETUP** button for at least 3 seconds.
- 2 Press the **▶▶I UP** or **I◀◀ DN** button to select the DEMO mode.
- 3 Press the **BAND** button to turn on or off the DEMO mode. Each press toggles between DEMO ON and DEMO OFF.

If no button is pressed for 30 seconds, the DEMO mode activates.

### NOTES

- The initial setting at the factory is "DEMO OFF."
- To quit DEMO mode, set to "DEMO OFF."

- 4 Press the **SETUP** button again to return to normal operation.

## Adjusting Display Contrast (CDA-7995 only)

---

You can adjust the display contrast for better visibility.

- 1 Press and hold the **SETUP** button for at least 3 seconds.
- 2 Press the **▶▶I UP** or **I◀◀ DN** button to select "CONTRAST."
- 3 Turn the **Rotary encoder** to adjust the contrast of the display. You can adjust in a range of -6 and +6. The initial setting at the factory is "0."
- 4 Press the **SETUP** button to set the selected mode.

# Radio Operation

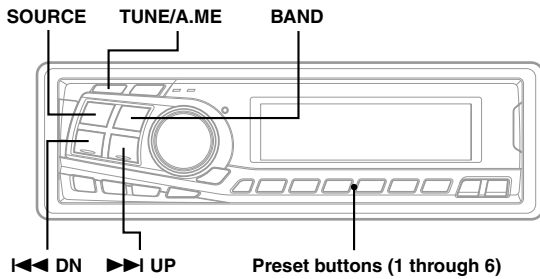

- 3 Press the **TUNE** button to illuminate the DX and SEEK indicators in the display.  
With the DX (Distance) mode activated, both strong and weak stations will be tuned in the Auto-Seek operation.  
Press again to return to the local mode. The DX indicator will turn off and the SEEK indicator will remain illuminated. Now, only strong stations will be tuned.
- 4 Press the **I◀◀ DN** or **▶▶ I UP** button to automatically seek for a station downward or upward respectively. The unit will stop at the next station it finds. Press the same button again to seek the next station.

## Manual Tuning

- 1 Press the **SOURCE** button until a radio frequency appears in the display.
- 2 Press the **BAND** button repeatedly until the desired radio band is displayed.  
Each press changes the band:  

→ FM1 → FM2 → AM →
--------------------
- 3 Press the **TUNE** button repeatedly until "DX SEEK" and "SEEK" disappear from the display.

### NOTE

The initial mode is DX SEEK.

- 4 Press the **I◀◀ DN** or **▶▶ I UP** button to move downward or upward one step respectively until the desired station frequency is displayed.

### NOTE

The ST indicator appears on the display when a Stereo FM station is tuned in.

## Automatic Seek Tuning

- 1 Press the **SOURCE** button until a radio frequency appears in the display.
- 2 Press the **BAND** button repeatedly until the desired radio band is displayed.

Each press changes the band:

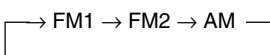

## Manual Storing of Station Presets

- 1 Select the radio band and tune in a desired radio station you wish to store in the preset memory.
- 2 Press and hold any one of the **Preset buttons (1 through 6)** that you want to store the station on for at least 2 seconds. The selected station is stored. The display shows the band, preset No. with a triangle (◀) and station frequency memorized.
- 3 Repeat the procedure to store up to 5 other stations onto the same band.  
To use this procedure for other bands, simply select the band desired and repeat the procedure.  
A total of 18 stations can be stored in the preset memory (6 stations for each band; FM1, FM2 and AM).

### NOTE

If you store a station in a preset memory which already has a station, the current station will be cleared and replaced with the new station.

## Automatic Memory of Station Presets

---

- 1** Press the **SOURCE** button to select the radio mode.
- 2** Press the **BAND** button repeatedly until the desired radio band is displayed.
- 3** Press and hold the **A. ME** button for at least 2 seconds. The frequency on the display continues to change while the automatic memory is in progress. The tuner will automatically seek and store 6 strong stations in the selected band. They will be stored into buttons 1 to 6 in order of signal strength.  
When the automatic memory has been completed, the tuner goes to the station stored in the preset location No. 1.

### **NOTE**

*If no stations are stored, the tuner will return to the original station you were listening to before the auto memory procedure began.*

## Tuning to Preset Stations

---

- 1** Press the **SOURCE** button to select the radio mode.
- 2** Press the **BAND** button repeatedly until the desired band is displayed.
- 3** Press the station **Preset** button that has your desired radio station in memory.  
The display shows the band, preset number with a triangle and frequency of the station selected.

# CD Player Operation

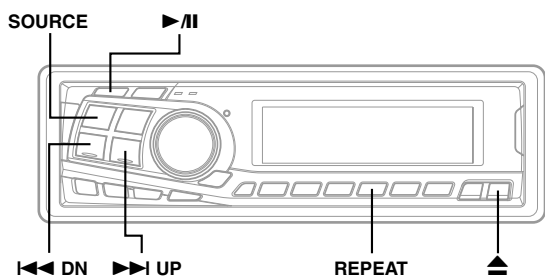

## Opening and Closing the Movable display

- 1 Press the  button.  
The movable display will open.

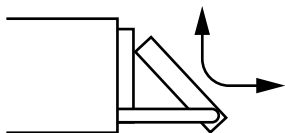

To close the movable display, press the  button again.  
The movable display will close.

### NOTES

- Do not apply shock to the movable display when it is open as it may result in malfunction of the unit.
- The display may be dim during low temperatures and immediately after turning on the power. The brightness will return to normal as time elapses.
- The display will stop at the set angle when closing.

### CAUTION

Keep hands (or any other object) away from the display while it is opening or closing to avoid damage or injury. The back of the movable display will get very warm under normal operating conditions. This is not a malfunction. Do not touch.

## Playback

- 1 Press the  button.  
The movable display will open.

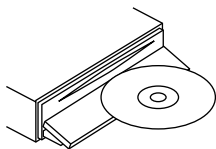



Insert a disc with the label side facing up.

- 2 Insert a disc with the label side facing up.  
The disc will be pulled into the unit automatically. The movable display will close and playback will begin.  
When a disc is already inserted, press the **SOURCE** button to switch to the CD mode.

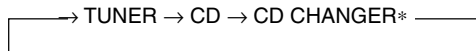
The mode will change every time the button is pressed.



(\* Only when the CD changer is connected)

- 3 To pause playback, press the  button.  
Pressing the  button again will resume playback.

- 4 To eject the disc, press the  button.

### NOTES

- Do not insert or remove a CD when loading or ejecting a CD, as malfunction may result.
- If the CD does not eject, press  button again for more than 3 seconds with the movable display open.

### About discs that can be used with the CDA-7995/CDA-7894 models.

We recommend using only compact discs containing the marks shown below.

You can play CD-Rs (CD-Recordable)/CD-RWs (CD-ReWritable) for audio use on this unit. You can also play CD-Rs/CD-RWs containing MP3 formatted audio files.

- Some of the following CDs may not play on this unit: Flawed CDs, CDs with fingerprints, CDs exposed to extreme temperatures or sunlight (e.g., left in the car or this unit), CDs recorded under unstable conditions, CDs on which a recording failed or a re-recording was attempted.
- Use discs with MP3 files written in the format compliant with ISO 9660 level 1 or level 2. For details, see page 26-27.



### About discs that can be used with the CDA-7893/CDA-7892 models.

We recommend using only compact discs containing the marks shown below.

You can play CD-Rs (CD-Recordable)/CD-RWs (CD-ReWritable) for audio use on this unit. You can not play CD-Rs/CD-RWs containing MP3 formatted audio files.

- Some of the following CDs may not play on this unit: Flawed CDs, CDs with fingerprints, CDs exposed to extreme temperatures or sunlight (e.g., left in the car or this unit), CDs recorded under unstable conditions, CDs not designed for audio use, CDs on which a recording failed or a re-recording was attempted.



### On handling Compact Discs (CD/CD-R/CD-RW)

- Do not touch the surface.
- Do not expose the disc to direct sunlight.
- Do not affix stickers or labels and do not write on the surface.
- Clean the disc when it is dusty.
- Make sure that there are no bumps around the disc.
- Do not use commercially available disc accessories.

**Do not leave the disc in the car or the unit for a long time. Never expose the disc to direct sunlight.** Heat and humidity may damage the CD and you may not be able to play it again.

## Music Sensor (Skip)

- 1 Momentarily press the **I◀◀ DN** button once during CD play to return to the beginning of the current track. If you wish to access the beginning of a track further back, repeatedly press until you reach the desired track.

Press the **▶▶I UP** button once to advance to the beginning of the next track. If you wish to access the beginning of a track further ahead, press repeatedly until the desired track is reached.

### NOTE

*The music sensor feature is functional in the play or pause mode.*

## Fast Forward and Backward

- 1 Press and hold the **I◀◀ DN** or **▶▶I UP** button to quickly move backward or forward until you reach the desired section of the track.

## Repeat Play

- 1 Press the **REPEAT** button to play back repeatedly the track being played. The track will be played repeatedly.

Press the **REPEAT** button again and select OFF to deactivate the repeat play.

### NOTES

- If a CD Changer is connected and the RPT ALL mode is selected, the unit repeatedly plays back all tracks on the disc selected.

→ RPT → RPT ALL → (off) —

- In case a 6-disc CD changer is connected:  
In CD changer mode, press the "F" button to illuminate the "FUNC" indicator and go to step 1 within 5 seconds.
- In case a 12-disc CD changer is connected:  
In changer mode, press the "F" button twice to illuminate the "FUNC" indicator and go to step 1 within 5 seconds.

# CD Player Operation

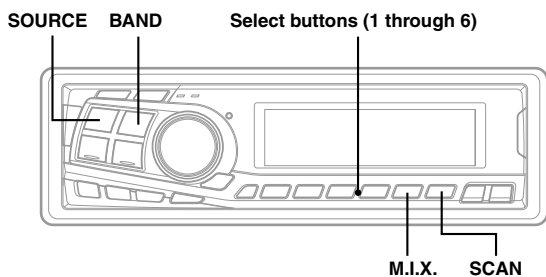

## M.I.X. (Random Play)

- 1 Press the **M.I.X.** button in the play or pause mode. The tracks on the disc will be played back in a random sequence.

To cancel M.I.X. play, press the **M.I.X.** button again to turn off the M.I.X.

### NOTES

- If a CD Changer equipped with the ALL M.I.X. function is connected, ALL M.I.X. will also be selectable. In this mode, the tracks on all the CDs in the current magazine will be included in the random playback sequence.

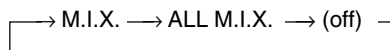

- In case a 6-disc CD changer is connected: In CD changer mode, press the "F" button to illuminate the "FUNC" indicator and go to step 1 within 5 seconds.
- In case a 12-disc CD changer is connected: In CD changer mode, press the "F" button twice to illuminate the "FUNC" indicator and go to step 1 within 5 seconds.

## Scanning Programs

- 1 Press the **SCAN** button to activate the Scan mode. The first 10 seconds of each track will be played back in succession.

To stop scanning, press the **SCAN** button and deactivate the Scan mode.

### NOTES

- In case a 6-disc CD changer is connected: In CD changer mode, press the "F" button to illuminate the "FUNC" indicator and go to step 1 within 5 seconds.
- In case a 12-disc CD changer is connected: In CD changer mode, press the "F" button twice to illuminate the "FUNC" indicator and go to step 1 within 5 seconds.

## Controlling CD Changer (Optional)

An optional 6-disc or 12-disc CD Changer may be connected to the CDA-7995/CDA-7894/CDA-7893/CDA-7892 if it is Ai-NET compatible. With a CD Changer connected to the Ai-NET input of the CDA-7995/CDA-7894/CDA-7893/CDA-7892, the CD Changer will be controllable from the CDA-7995/CDA-7894/CDA-7893/CDA-7892.

Using the KCA-400C (Multi-Changer Switching device) or the KCA-410C (Versatile Link Terminal) multiple changers can be controlled by the CDA-7995/CDA-7894/CDA-7893/CDA-7892.

See the Multi-Changer Selection section on page 23 for selecting the CD Changers.

### NOTES

- The controls on the CDA-7995/CDA-7894/CDA-7893/CDA-7892 for CD Changer operation are operative only when a CD Changer is connected.
- The "Changer" indicator illuminates when a CD Changer is connected.
- The DVD changer (optional) is controllable from the CDA-7995/CDA-7894/CDA-7893/CDA-7892 as well as the CD changer.

- 1 Press the **SOURCE** button to activate the CHANGER mode. The display shows the disc number and track number.

### NOTE

The source indicator varies depending on the connected source.

- 2 Press the Disc **Select buttons (1 through 6)** corresponding to one of the discs loaded in the CD Changer. The selected disc number appears in the display and CD playback starts.

### NOTES

- After selecting the desired disc, you can operate in the same way as for the CDA-7995/CDA-7894/CDA-7893/CDA-7892 CD player. For details, please see the CD Operation section.
- If the "FUNC" indicator is illuminated the Disc Select buttons become nonfunctional.

### When a 12-disc CD Changer is connected:

To select discs numbered from 1 to 6, the procedure is the same as for the 6-disc CD Changer. To select discs numbered from 7 to 12, first press the "F" button. This changes the "D" indicator to "d." Then press the desired Preset button. With the "F" button activated, the Preset buttons 1 to 6 will represent discs 7 to 12 respectively.



## Multi-Changer Selection

Alpine's Ai-NET system will support up to 6 CD Changers. When operating two or more changers, the KCA-400C (Multi-Changer Switching device) must be used. If you use 1 Switching device, you can connect up to 4 CD Changers. If you use 2 Switching devices, you can connect up to 6 CD Changers. When using KCA-410C (Versatile Link Terminal), you can connect two changers and two external outputs (AUX).

- 1 Press the **SOURCE** button on the CDA-7995/CDA-7894/CDA-7893/CDA-7892 to activate the CD Changer mode.

Alternatively, press the **SOURCE** button on the Remote Control (RUE-4187) to activate the CD Changer mode.

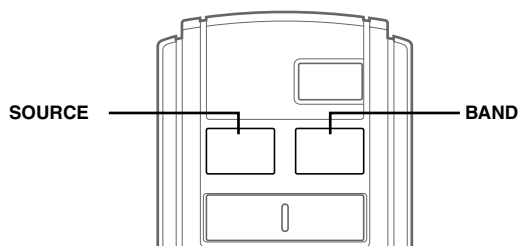

- 2 Press the **BAND** button on the CDA-7995/CDA-7894/CDA-7893/CDA-7892 or the RUE-4187 to activate the CD Changer Selection mode.

- 3 The CD Changer Selection mode remains active for 8 seconds after step 2 is performed. Press the **BAND** button until the desired CD Changer indicator appears on the display.

### **NOTE**

*If the selected CD Changer is not connected, the display will show "NO CHGR."*

Alternatively press the **BAND** button on the Remote Control until the desired changer indicator appears on the display.

- 4 To operate the selected changer, see "CD Player Operation" section.

### **NOTE**

*For further details about the external input (AUX) when using KCA-410C, see "Setting the AUX Mode (V-Link)" on page 15.*

# MP3 Operation

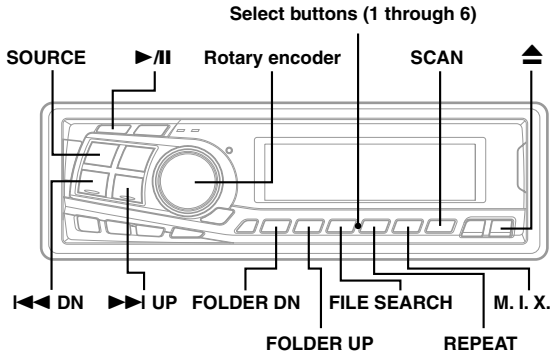

## Playing MP3 Files (CDA-7995/CDA-7894 only)

The CDA-7995/CDA-7894 models include a built-in MP3 unit. You can play CD-ROMs, CD-Rs, and CD-RWs containing MP3 files on this unit. Use the format compliant with ISO 9660 level 1 or level 2. For further information about playing or storing MP3 files, refer to pages 26 - 27 before using the unit.

- 1 Press the ▲ button.  
The movable display will open.

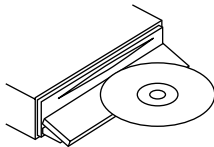

Insert a disc containing an MP3 file with the label side facing up.

- 2 Insert a disc containing an MP3 file with the label side facing up.  
The disc will be pulled into the unit automatically. The movable display will close and playback will begin. When a disc is already inserted, press the **SOURCE** button to switch to the CD mode.

The mode will change every time the button is pressed.

→ TUNER → CD → CD CHANGER\* →

(\* Only when the CD changer is connected)

- 3 To pause playback, press the ▶/|| button.  
Pressing the ▶/|| button again will resume playback.
- 4 To eject the disc, press the ▲ button.

### NOTES

- The unit can play discs containing both audio data and MP3 data.
- The MP3 indicator is lit during MP3 playback.

## Playing MP3 Files with the CD Changer (Optional)

If you connect a changer compatible with MP3, you can play CD-ROMs, CD-Rs, and CD-RWs containing MP3 files on the CDA-7995/CDA-7894/CDA-7893/CDA-7892.

- 1 Press the **SOURCE** button to switch to the MP3 Changer mode.  
The mode will change every time the button is pressed.  
The display shows the disc number and Folder number.  
For CDA-7995/CDA-7894/CDA-7893, Folder Number, File Number and Elapsed Time are displayed. For CDA-7892, File Number, Folder Number\* and Elapsed Time are displayed.  
\*Press and hold the TITLE button for at least 3 seconds to change the File Number display to the Folder Number display alternately.
- 2 Press the Disc **Select buttons (1 through 6)** corresponding to one of the discs loaded in the CD Changer.
- 3 To pause playback, press the ▶/|| button.  
Pressing the ▶/|| button again will resume playback.

### NOTE

The unit can play discs containing both audio data and MP3 data.

## Music Sensor (Skip)

- 1 Momentarily press the ◀◀ DN button once during CD play to return to the beginning of the current file. If you wish to access the beginning of a file further back, repeatedly press until you reach the desired file.  
  
Press the ▶▶ UP button once to advance to the beginning of the next file. If you wish to access the beginning of a file further ahead, press repeatedly until the desired file is reached.

### NOTES

- The music sensor feature is functional in the play or pause mode.
- Files are played back in their pathname order which was used when they were written to the CD.

## Fast Forward and Backward

- 1 Press and hold the **◀◀ DN** or **▶▶ UP** button to quickly move backward or forward until you reach the desired section of the file.

### NOTE

There is no audio output during fast forward/backward for MP3 files.

## Selecting Folders

- 1 Press the **FOLDER DN** or **FOLDER UP** button to select the folder.

### NOTE

If a CD changer applicable to MP3 is connected:  
In CD changer mode, press the "F" button to illuminate the "FUNC" indicator and go to step 1 within 5 seconds.

## File Search

You can locate all the files on a disc and play them.

- 1 Press the **FILE SEARCH** button during playback. The unit switches to File Search mode.
- 2 Turn the **Rotary encoder** to select the desired file.
- 3 Press the **Rotary encoder** to execute the setting. The selected file starts to play.

### NOTES

- During search, press the **FILE SEARCH** button to cancel the File Search mode.
- If a CD changer applicable to MP3 is connected:  
In CD changer mode, press the "F" button to illuminate the "FUNC" indicator and go to step 1 within 5 seconds.

## Repeat Play

- 1 Press the **REPEAT** button to play back repeatedly the file being played. The file will be played repeatedly.

Press the **REPEAT** button again and select OFF to deactivate the repeat play.

### NOTES

- If a CD changer applicable to MP3 is connected and the **RPT ALL** mode is selected, the unit repeatedly plays back all files on the selected disc.

→ RPT → RPT ALL → (off) →

- When you select "FOLDER" and set to **RPT ALL** in the "Setting the Range of MP3 File Selection" section on page 26, the Files will be repeatedly played back.
- If a CD changer applicable to MP3 is connected:  
In CD changer mode, press the "F" button to illuminate the "FUNC" indicator and go to step 1 within 5 seconds.

## M.I.X. (Random Play)

- 1 Press the **M.I.X.** button in the play or pause mode. The files on the disc will be played back in a random sequence.

To cancel M.I.X. play, press the **M.I.X.** button again to turn off the M.I.X.

### NOTES

- If an MP3 compatible CD changer with the **ALL M.I.X.** function is connected, **ALL M.I.X.** will also be selectable. When setting to M.I.X., the unit will play back the next disc after playing back all files in the current disc. When set to **ALL M.I.X.**, the unit will play one file from each disc sequentially.

→ M.I.X. → ALL M.I.X. → (off) →

- When you select "FOLDER" and set to M.I.X. in the "Setting the Range of MP3 File Selection" section on page 26, the Files in the Folder are played back in random sequence. After all the files have been played back, play does not shift to the next Folder.
- In case an MP3 compatible CD changer is connected:  
In CD changer mode, press the "F" button to illuminate the "FUNC" indicator and go to step 1 within 5 seconds.

## Scanning Programs

- 1 Press the **SCAN** button to activate the Scan mode. The first 10 seconds of each file will be played back in succession.

To stop scanning, press the **SCAN** button and deactivate the Scan mode.

### NOTES

- When you select "FOLDER" in the "Setting the Range of MP3 File Selection" section on page 26, the first 10 seconds of each File in the Folder will be played back.
- If a CD changer applicable to MP3 is connected:  
In CD changer mode, press the "F" button to illuminate the "FUNC" indicator and go to step 1 within 5 seconds.

# MP3 Operation

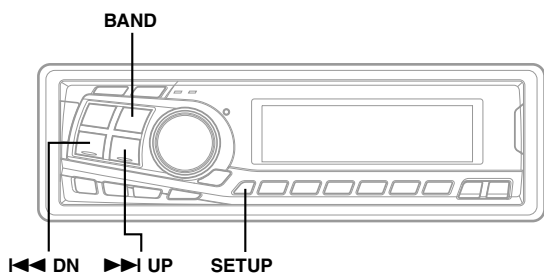

## Setting the Range of MP3 File Selection

You can set the range of MP3 file selection to "entire disc contents" or "folder contents only."

- 1 Press and hold the **SETUP** button for at least 3 seconds.
- 2 Press the **▶▶ UP** or **◀◀ DN** button to select DISC/ FOLDER (file selection range).
- 3 Press the **BAND** button to toggle the mode between DISC ALL and FOLDER.
  - DISC ALL : plays all the files on one disc
  - FOLDER : plays files in the selected folder only.

### NOTE

The initial setting at the factory is DISC ALL.

- 4 Press the **SETUP** button to set the selected mode.

## Playing MP3 Data

You can select either playback only of CD data, or playback of formatted CD data and MP3 files. When a disc contains CD or the MP3 file data, playback starts from the CD data portion of the disc.

- 1 Press and hold the **SETUP** button for at least 3 seconds.

- 2 Press the **▶▶ UP** or **◀◀ DN** button to select "CD-DA/MP3."
- 3 Press the **BAND** button to toggle the mode between CD-DA and CD-DA/MP3 (CD/MP3 is displayed on the CDA-7892 model).
  - CD-DA: Only CD data can be played back.
  - CD-DA/MP3: Both CD data and MP3 file tracks can be played back.  
(For the CDA-7892 model, CD/MP3 are displayed)
- 4 Press the **SETUP** button to return to normal mode.

## About MP3

### CAUTION

Except for personal enjoyment, duplicating audio data (including MP3 data) or distributing, transferring, or copying it, whether for free or for a fee, without the permission of the copyright holder is strictly prohibited by the Copyright Act and by international treaty.

### • What is MP3?

MP3, whose official name is "MPEG Audio Layer 3", is a compression standard prescribed by the ISO, the International Standardization Organization and MPEG which is a joint activity institution of the IEC.

MP3 files contain compressed audio data. MP3 encoding is capable of compressing the audio data at extremely high ratios shrinking music files by as much as one-tenth their original size. This is achieved while still maintaining near CD quality. The MP3 format realizes such high compression ratios by eliminating the sounds that are either inaudible to the human ear or masked by other sounds.

### • Method for creating MP3 files

The software used to create MP3 files is widely sold or free from various sources. For details on creating MP3 files, refer to the user's manual for that software. The MP3 files that can be played back by this device have the file extension "mp3". Files with no extension can not be played back.

- **Supported playback sampling rates and bit rates**

Sampling rates: 8 kHz - 44.1 kHz, bit rates: 8 - 320 kbps  
Note that for sampling rates such as 11,025 kHz, this device's frame display (Page 12) may not display correctly.

- **ID3 tags**

This device supports ID3 tag v1.  
If ID3 tag data is in an MP3 file, this device can display the title (track title), artist name, and album name ID3 tag data.

This device can only display single-byte alphanumeric characters and the underscore. For non-supported characters, "NO SUPPORT" is displayed.

- **Producing MP3 discs**

MP3 files are prepared, then written to a CD-R or CD-RW using CD-R writing software. A disc can hold up to 512 files/folders (including Root Folders).

- **Media supported**

The media that this device can play back are CD-ROMs, CD-Rs, and CD-RWs.

- **Corresponding File Systems**

This device supports discs formatted with ISO9660 Level 1 or Level 2.

Under the ISO9660 standard, there are some restrictions to remember.  
The maximum nested folder depth is 8 (including the root directory). File/folder names are limited to 31 characters (including the extension).  
Valid characters for folder/file names are letters A-Z (all caps), numbers 0-9, and '\_' (underscore).

This device also can play back discs in Joliet, and other standards that conform to ISO9660. However, sometimes the file names, folder names, etc. are not displayed correctly.

- **Formats supported**

This device supports CD-ROM XA, Mixed Mode CD, Enhanced CD (CD-Extra) and Multi-Session.  
This device can not correctly play back discs recorded with Track At Once or packet writing.

- **Order of tracks**

Track playback is based on the pathname order used for the files when they were written to the CD.

- When CD audio and MP3 files are both present on a disk, playback starts from Folder No. 1.  
Also, the track display for CD audio data playback is the track numbers recorded on the disc.

## Terminology

### Bit rate

This is the "sound" compression rate specified for encoding. The higher the bit rate, the higher the sound quality, but also the larger the files.

### Sampling rate

This value shows how many times per second the data is sampled (recorded). For example, music CDs use a sampling rate of 44.1 kHz, so the sound level is sampled (recorded) 44,100 times per second. The higher the sampling rate, the higher the sound quality, but also the larger the volume of data.

### Encoding

Converting music CDs, WAVE (AIFF) files, and other sound files into the specified audio compression format.

### ID3 tag

Song information such as track titles, artist names, album names, etc., written into MP3 files.

# XM Radio Operation

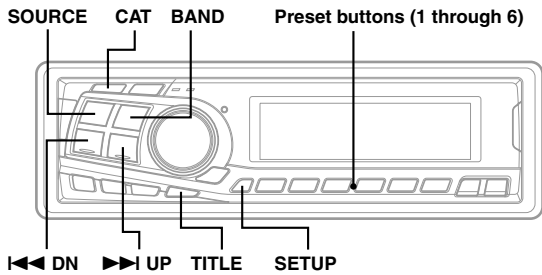

## Receiving XM Channels with the XM Receiver (Optional)

XM Satellite Radio\* is the next generation of audio entertainment, with up to 100 brand-new digital channels. For a small monthly fee, subscribers can hear crystal-clear music, sports, news and talk, coast-to-coast via satellite. For more information, visit XM's website at [www.xmradio.com](http://www.xmradio.com) or call 1-877-XMRADIO.

An optional XM Satellite Radio Receiver (TUA-T020XM) may be connected to the CDA-7995/CDA-7894/CDA-7893/CDA-7892 if it is Ai-NET compatible. With an XM Receiver connected to the Ai-NET input of the CDA-7995/CDA-7894/CDA-7893/CDA-7892, the XM Receiver will be controllable from the CDA-7995/CDA-7894/CDA-7893/CDA-7892.

\* XM and its corresponding logos are trademarks of XM Satellite Radio Inc.

### NOTES

- The controls on the CDA-7995/CDA-7894/CDA-7893/CDA-7892 for XM Receiver operation are operative only when an XM Receiver is connected.
- The XM1 or XM2 band illuminates when in XM mode.

**1** Press the **SOURCE** button to select RADIO Mode.

**2** Press the **BAND** button to select XM1 or XM2.

Each press changes the band:

→ FM1 → FM2 → XM1 → XM2 → AM →

**3** Press the **I<=< DN** or **>=> I UP** button to select the desired channel. Holding the **I<=< DN** or **>=> I UP** buttons will change channels continuously.

## Checking the XM Radio ID Number

You need to provide XM with the unique XM Radio ID number for your XM Radio Receiver in order to subscribe to XM's programming.

This number is an 8 character alphanumeric number that is printed on a label directly on the XM Receiver. It can also be displayed on the screen of the CDA-7995/CDA-7894/CDA-7893/CDA-7892 in the following way.

**1** While receiving XM1/XM2, press the **I<=< DN** or **>=> I UP** button to select channel "0."

**2** The unit alternately displays "RADIO ID" for 2 seconds, then the ID number for 10 seconds.

**3** To cancel the ID number display, set the channel to other than "0."

### Tips

There is another way to display your ID number.

1. Press and hold the **SETUP** button for at least 3 seconds.
2. Press the **>=> I UP** or **I<=< DN** button repeatedly to select "ID."
3. Press the **BAND** button to display your ID number.
4. After checking your ID number, press the **SETUP** button to return to the normal display.

### NOTES

- You cannot use "O," "S," "I," or "F" for the ID Number.
- You can check your ID number printed on the label on the package of your XM Satellite Radio Receiver (TUA-T020XM).

## Storing XM Channel Presets

- 1 Press the **BAND** button to select the desired band (XM1 or XM2) you want to store.
- 2 After tuning in the desired channel, press and hold any one of the **Preset buttons (1 through 6)** that you want to store the station on for at least 2 seconds. The selected station is stored.
- 3 Repeat the procedure to store up to 5 other channels onto the same band.  
To use this procedure for other bands, simply select the band desired and repeat the procedure.  
A total of 12 channels can be stored in the preset memory (6 channels for each band; XM1 and XM2).

### NOTE

If you store a channel in a preset memory which already has a station, the current channel will be cleared and replaced with the new one.

## Receiving Stored XM Channels

- 1 Press the **BAND** button to select the desired band (XM1 or XM2).  

→ FM1 → FM2 → XM1 → XM2 → AM ←
- 2 Press the channel **Preset** button that has your desired satellite channel in memory.

## Category Search

Category Search functionality allows you to search for a specific channel by the category of programming it offers, or to surf within a given category.

- 1 In XM mode, press the **CAT** button to display the category of the channel that is currently selected for 5 seconds.
- 2 While the category is displayed, press the **◀◀ DN** or **▶▶ UP** button to select a different category (or leave it to stay with the same category.)
- 3 Within 5 seconds of selecting the category, press the **CAT** button again to select the next channel within that category. Repeatedly press the **CAT** button within 5 seconds to select additional channels within that category.

When tuned in, the category is displayed for 5 seconds, then the display returns to normal mode.

### NOTE

If you cannot find your desired category, the display shows “----” for 2 seconds automatically.

## Changing the Display

Text information, such as the channel name, artist name/feature, and song/program title, is available with each XM channel. The unit can display this text information as explained below.

- 1 In XM mode, press the **TITLE** button.  
Each time you press this button, the display changes as shown below.

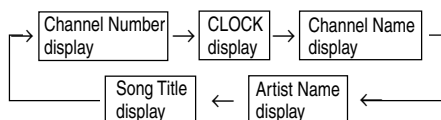

### NOTES

- When The “Scroll Setting” (refer to page 15) is set to “SCR AUTO”, the display scrolls.  
When the CD Text Scroll Setting is set to “SCR MANUAL” (CDA-7892: “SCR MANU”), the display scrolls only when you operate the unit (POWER ON, BAND, etc., are displayed).  
Press and hold the **TITLE** button for more than 3 seconds to scroll the display again.
- “Channel Number” and “Clock” displays do not scroll.
- Depending on the model, the display may differ from the one shown above.

# Remote Control Operation

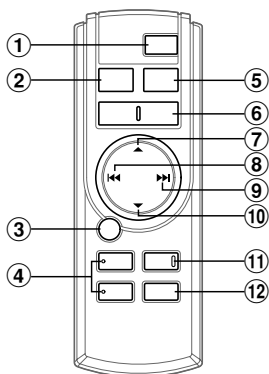

## Controls on Remote Control

- ① **Power Button**  
Press the button to turn the power on/off.
- ② **Source Button**  
Press to select the audio source.
- ③ **▶/|| Button**  
Press the button to switch between the Play and Pause modes for CD.
- ④ **ANGLE ▲▼ Buttons**  
Press the button to adjust the angle of the movable display.
- ⑤ **Band/Program Button**  
Radio mode: BAND Button  
Press the button and the band will change as shown below.
- ⑥ **Volume Adjustment Buttons**  
To increase the volume level:  
Press the ▲ button  
To decrease the volume level:  
Press the ▼ button
- ⑦ **▲ Button**  
Radio mode: Pressing the button will select, in ascending order, stations programmed into the radio's presets as shown below.

→ FM1 → FM2 → XM1 → XM2 → AM →

→ 1 → 2 ... 6 →

CD Changer mode: DISC Select (UP) Button  
Press the button to select a disc in ascending order.

- ⑧ **◀◀ DN Button**  
Radio mode: SEEK (DN) Button  
CD mode: Press the button to go back to the beginning of the current track.
- ⑨ **▶▶ UP Button**  
Radio mode: SEEK (UP) Button  
CD mode: Press the button to advance to the beginning of the next track.
- ⑩ **▼ Button**  
Radio mode: Pressing the button will select, in descending order, stations programmed into the radio's presets as shown below.
- ⑪ **Mute Button**  
Press the button to lower the volume by 20 dB instantly. Press the button again to cancel.
- ⑫ **Audio Processor Button\*\***  
Press the button to call the external audio processor mode.\*

→ 6 → 5 ... 1 →

CD Changer mode: DISC Select (DN) Button  
Press the button to select a disc in descending order.

\* For the operation of external audio processor, refer to the Owner's Manual of the external audio processor you purchased.  
\*\* This button is used in conjunction with an optional Ai-NET processor.



## Battery Replacement

Applicable battery: Use two “AAA” sized dry batteries or equivalent.

- 1** Opening the battery cover  
Slide out the battery cover while firmly pressing the direction of arrow.

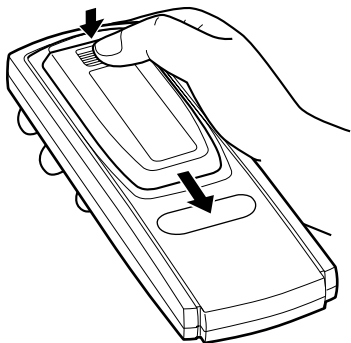

- 2** Replacing the battery  
Put the batteries in the case observing the polarities as illustrated.

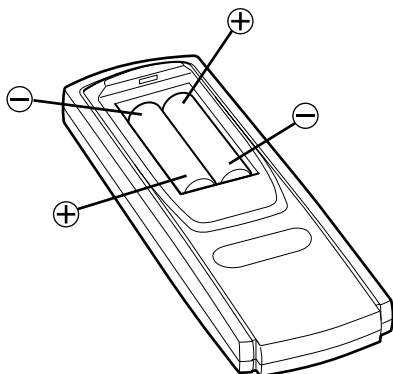

- 3** Closing the cover  
Push the cover as illustrated until a click is heard.

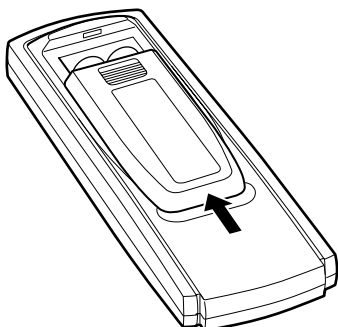

Point the remote control transmitter at the remote control sensor.

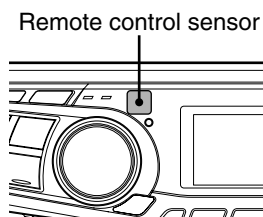

# Information

## In Case of Difficulty

---

If you encounter a problem, please turn the power off, then on again. If the unit is still not functioning normally, please review the items in the following checklist. This guide will help you isolate the problem if the unit is at fault. Otherwise, make sure the rest of your system is properly connected or consult your authorized Alpine dealer.

### Basic

---

#### No function or display.

- Vehicle's ignition is off.
  - If connected following instructions, the unit will not operate with the vehicle's ignition off.
- Improper power lead connections.
  - Check power lead connections.
- Blown fuse.
  - Check the fuse on the battery lead of the unit; replace with the proper value if necessary.
- Internal micro-computer malfunctioned due to interference noise etc.
  - Press the RESET switch with a ballpoint pen or other pointed article.

### Radio

---

#### Unable to receive stations.

- No antenna or open connection in cable.
  - Make sure the antenna is properly connected; replace the antenna or cable if necessary.

#### Unable to tune stations in the seek mode.

- You are in a weak signal area.
  - Make sure the tuner is in the DX mode.
- If the area you are in is a primary signal area, the antenna may not be grounded and connected properly.
  - Check your antenna connections; make sure the antenna is properly grounded at its mounting location.
- The antenna may not be the proper length.
  - Make sure the antenna is fully extended; if broken, replace the antenna with a new one.

#### Broadcast is noisy.

- The antenna is not the proper length.
  - Extend the antenna fully; replace it if it is broken.
- The antenna is poorly grounded.
  - Make sure the antenna is grounded properly at its mounting location.

### CD

---

#### CD Player/Changer not functioning.

- Out of operating temperature range +50°C (+120°F) for CD.
  - Allow the vehicle's interior (or trunk) temperature to cool.

#### CD playback sound is wavering.

- Moisture condensation in the CD Module.
  - Allow enough time for the condensation to evaporate (about 1 hour).

#### CD insertion not possible.

- A CD is already in the CD player.
  - Eject the CD and remove it.
- The CD is being improperly inserted.
  - Make sure the CD is being inserted following instructions in the CD Player Operation section.

#### Unable to fast forward or backward the CD.

- The CD has been damaged.
  - Eject the CD and discard it; using a damaged CD in your unit can cause damage to the mechanism.

#### CD playback sound skips due to vibration.

- Improper mounting of the unit.
  - Securely re-mount the unit.
- Disc is very dirty.
  - Clean the disc.
- Disc has scratches.
  - Change the disc.
- The pick-up lens is dirty.
  - Do not use a commercial available lens cleaner disc. Consult your nearest ALPINE dealer.

#### CD playback sound skips without vibration.

- Dirty or scratched disc.
  - Clean the disc; damaged disc should be replaced.

#### Error displays (built-in CD player only)

- Mechanical error
  - Press the ▲ button. After the error indication disappears, insert the disc again. If the above-mentioned solution does not solve the problem, consult your nearest ALPINE dealer.

### MP3

---

#### MP3 is not played back.

- Writing error occurred. The CD format is not compatible.
  - Make sure the CD has been written in a supported format. Refer to "About MP3" on pages 26-27, then rewrite in the format supported by this device.

## Indication for CD Player

---

### HITEMP

- Protective circuit is activated due to high temperature.
  - The indicator will disappear when the temperature returns to within operation range.

### NO DISC

- No CD is inserted.
  - Insert a CD.
- Although a disc is inserted, "NO DISC" is displayed and the unit does not start to play or eject the disc.
  - Remove the disc by following these steps:
    - 1) Press the **▲** button.  
The movable display will open.
    - 2) Press the **▲** button again for at least 3 seconds while the movable display is open.

### ERROR

- Mechanism error.
  - 1) Press the **▲** button and eject the CD.  
If not ejecting, consult your Alpine dealer.
  - 2) When the error indication remains after ejecting, press the **▲** button again.  
If the error indication still does not turn off after pressing the **▲** button for a few times, consult your Alpine dealer.

#### NOTE

When the "ERROR" is displayed:

In case that the disc cannot be ejected by pressing the **▲** button, press the RESET switch (refer to page 5) and press the **▲** button again.

If not ejecting, consult your Alpine dealer.

## Indication for CD Changer

---

### HITEMP

- Protective circuit is activated due to high temperature.
  - The indicator will disappear when the temperature returns to within operation range.

### ERROR - 01

- Malfunction in the CD Changer.
  - Consult your Alpine dealer. Press the magazine eject button and pull out the magazine.  
Check the indication. Insert the magazine again.  
If the magazine cannot be pulled out, consult your Alpine dealer.
- Magazine ejection not possible.
  - Press the magazine eject button. If the magazine does not eject, consult your Alpine dealer.

### ERROR - 02

- A disc is left inside the CD Changer.
  - Press the Eject button to activate the eject function. When the CD Changer finishes the eject function, insert an empty CD magazine into the CD Changer to receive the disc left inside the CD Changer.

### NO MAGZINE

(CDA-7995/CDA-7894/CDA-7893)

### NO MAGZN

(CDA-7892)

- No magazine is loaded into the CD Changer.
  - Insert a magazine.

### NO DISC

- No indicated disc.
  - Choose another disc.

# Information

## Indication for XM Radio Mode

---

### ANTENNA

- The XM antenna is not connected to the XM radio module.
    - Check whether the XM antenna cable is attached securely to the XM radio module.
- 

### UPDATING

- Radio is being updated with latest encryption code.
    - Wait until encryption code is being updated. Channels 0 and 1 should function normally.
- 

### NO SIGNAL

- XM signal is too weak at the current location.
    - Wait until the car reaches a location with a stronger signal.
- 

### LOADING

- Radio is acquiring audio or program information.
    - Wait until the radio has received the information.
- 

### OFF AIR

- The channel currently selected has stopped broadcasting.
    - Select another channel.
- 

-----

(CDA-7995-CDA-7894/CDA-7893 only)

-----

(CDA-7892 only)

- The user has selected a Channel Number that does not exist or is not subscribed to.
    - The unit will revert back to the previously selected channel.
  - There is no artist name/feature, song/program title, or additional information associated with the channel at that time.
    - No action needed.
-

# Specifications

---

## FM TUNER SECTION

Tuning Range	87.7 – 107.9 MHz
Mono Usable Sensitivity	9.3 dBf (0.8 $\mu$ V/75 ohms)
50 dB Quieting Sensitivity	13.5 dBf (1.3 $\mu$ V/75 ohms)
Alternate Channel Selectivity	80 dB
Signal-to-Noise Ratio	80 dB
Stereo Separation	45 dB
Capture Ratio	2.0 dB

## AM TUNER SECTION

Tuning Range	530 – 1,710 kHz
Sensitivity (IEC Standard)	22.5 $\mu$ V/27 dB

## CD PLAYER SECTION

Frequency Response	5 – 20,000 Hz ( $\pm$ 1 dB)
Wow & Flutter (% WRMS)	Below measurable limits
Total Harmonic Distortion	0.008% (at 1 kHz)
Dynamic Range	95 dB (at 1 kHz)
Signal-to-Noise Ratio	105 dB
Channel Separation	85 dB (at 1 kHz)

## PICKUP

Wave length	795 nm
Laser power	CLASS I

## REMOTE CONTROL

Battery Type	AAA batteries (2 pcs.)
Width	42 mm (1-21/32")
Height	121 mm (4-25/32")
Depth	23 mm (29/32")
Weight	50 g (1.8 oz)

## GENERAL

Power Requirement	14.4 V DC (11–16 V allowable)
Maximum Power Output	60 W $\times$ 4 (CDA-7894/CDA-7893 only) 50W $\times$ 4 (CDA-7892 only)
Maximum Pre-Output Voltage	4 V/10 k ohms (CDA-7995/ CDA-7894 only) 2V/10k ohms (CDA-7893/ CDA-7892 only)
Maximum Subwoofer Output Voltage	4 V/10 k ohms
Bass	$\pm$ 14 dB at 60 Hz
Treble	$\pm$ 14 dB at 10 kHz
Weight	1.5 kg (3 lbs. 5 oz)

## CHASSIS SIZE

Width	178 mm (7")
Height	50 mm (2")
Depth	155 mm (6-1/8")

## NOSEPIECE SIZE

Width	170 mm (6-11/16")
Height	46 mm (1-13/16")
Depth	18 mm (11/16")

Due to continuous product improvement, specifications and design are subject to change without notice.

# Installation and Connections

Before installing or connecting the unit, please read the following and pages 3 and 4 of this manual thoroughly for proper use.

## Warning

### **MAKE THE CORRECT CONNECTIONS.**

Failure to make the proper connections may result in fire or product damage.

### **USE ONLY IN CARS WITH A 12 VOLT NEGATIVE GROUND.**

(Check with your dealer if you are not sure.) Failure to do so may result in fire, etc.

### **BEFORE WIRING, DISCONNECT THE CABLE FROM THE NEGATIVE BATTERY TERMINAL.**

Failure to do so may result in electric shock or injury due to electrical shorts.

### **DO NOT ALLOW CABLES TO BECOME ENTANGLED IN SURROUNDING OBJECTS.**

Arrange wiring and cables in compliance with the manual to prevent obstructions when driving. Cables or wiring that obstruct or hang up on places such as the steering wheel, gear lever, brake pedals, etc. can be extremely hazardous.

### **DO NOT SPLICE INTO ELECTRICAL CABLES.**

Never cut away cable insulation to supply power to other equipment. Doing so will exceed the current carrying capacity of the wire and result in fire or electric shock.

### **DO NOT DAMAGE PIPE OR WIRING WHEN DRILLING HOLES.**

When drilling holes in the chassis for installation, take precautions so as not to contact, damage or obstruct pipes, fuel lines, tanks or electrical wiring. Failure to take such precautions may result in fire.

### **DO NOT USE BOLTS OR NUTS IN THE BRAKE OR STEERING SYSTEMS TO MAKE GROUND CONNECTIONS.**

Bolts or nuts used for the brake or steering systems (or any other safety-related system), or tanks should NEVER be used for installations or ground connections. Using such parts could disable control of the vehicle and cause fire etc.

### **KEEP SMALL OBJECTS SUCH AS BATTERIES OUT OF THE REACH OF CHILDREN.**

Swallowing them may result in serious injury. If swallowed, consult a physician immediately.

### **DO NOT INSTALL IN LOCATIONS WHICH MIGHT HINDER VEHICLE OPERATION, SUCH AS THE STEERING WHEEL OR GEARSHIFT.**

Doing so may obstruct forward vision or hamper movement etc. and results in serious accident.

## Caution

### **HAVE THE WIRING AND INSTALLATION DONE BY EXPERTS.**

The wiring and installation of this unit requires special technical skill and experience. To ensure safety, always contact the dealer where you purchased this product to have the work done.

### **USE SPECIFIED ACCESSORY PARTS AND INSTALL THEM SECURELY.**

Be sure to use only the specified accessory parts. Use of other than designated parts may damage this unit internally or may not securely install the unit in place. This may cause parts to become loose resulting in hazards or product failure.

### **ARRANGE THE WIRING SO IT IS NOT CRIMPED OR PINCHED BY A SHARP METAL EDGE.**

Route the cables and wiring away from moving parts (like the seat rails) or sharp or pointed edges. This will prevent crimping and damage to the wiring. If wiring passes through a hole in metal, use a rubber grommet to prevent the wire's insulation from being cut by the metal edge of the hole.

### **DO NOT INSTALL IN LOCATIONS WITH HIGH MOISTURE OR DUST.**

Avoid installing the unit in locations with high incidence of moisture or dust. Moisture or dust that penetrates into this unit may result in product failure.

## Precautions

- Be sure to disconnect the cable from the (-) battery post before installing your CDA-7995/CDA-7894/CDA-7893/CDA-7892. This will reduce any chance of damage to the unit in case of a short-circuit.
- Be sure to connect the color coded leads according to the diagram. Incorrect connections may cause the unit to malfunction or damage to the vehicle's electrical system.
- When making connections to the vehicle's electrical system, be aware of the factory installed components (e.g. on-board computer). Do not tap into these leads to provide power for this unit. When connecting the CDA-7995/CDA-7894/CDA-7893/CDA-7892 to the fuse box, make sure the fuse for the intended circuit of the CDA-7995/CDA-7894/CDA-7893/CDA-7892 has the appropriate amperage. Failure to do so may result in damage to the unit and/or the vehicle. When in doubt, consult your ALPINE dealer.
- The CDA-7995/CDA-7894/CDA-7893/CDA-7892 uses female RCA-type jacks for connection to other units (e.g. amplifier) having RCA connectors. You may need an adaptor to connect other units. If so, please contact your authorized ALPINE dealer for assistance.
- Be sure to connect the speaker (-) leads to the speaker (-) terminal. Never connect left and right channel speaker cables to each other or to the vehicle body.

## IMPORTANT

Please record the serial number of your unit in the space provided below and keep it as a permanent record. The serial number plate is located on the bottom of the unit.

SERIAL NUMBER: \_\_\_\_\_  
INSTALLATION DATE: \_\_\_\_\_  
INSTALLATION TECHNICIAN: \_\_\_\_\_  
PLACE OF PURCHASE: \_\_\_\_\_

# Installation

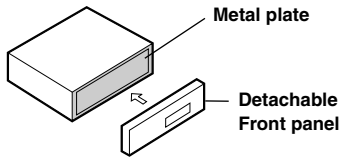

### Caution

When you install this unit in your car, do not remove the Detachable Front Panel.  
If the Detachable Front Panel is removed during installation, you might press too hard and warp the metal plate that holds it in place.

1

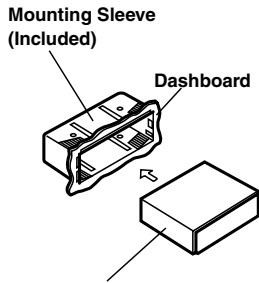

CDA-7995/CDA-7894/CDA-7893/CDA-7892

Slide the mounting sleeve into the dashboard.

2

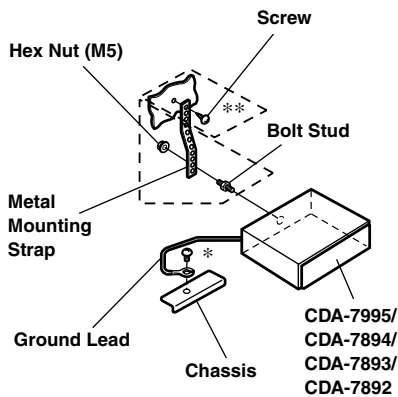

Reinforce the head unit with the metal mounting strap (not supplied). Secure the ground lead of the unit to a clean metal spot using a screw (\*) already attached to the vehicle's chassis.

### NOTE

For the screw marked \*\*, use an appropriate screw for the chosen mounting location.

Connect each input lead coming from an amplifier or equalizer to the corresponding output lead coming from the left rear of the CDA-7995/CDA-7894/CDA-7893/CDA-7892. Connect all other leads of the CDA-7995/CDA-7894/CDA-7893/CDA-7892 according to details described in the CONNECTIONS section.

3

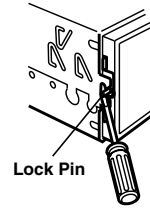

Slide the CDA-7995/CDA-7894/CDA-7893/CDA-7892 into the dashboard. When the unit is in place, make sure the locking pins are fully seated in the down position. This can be done by pressing firmly in on the unit while pushing the locking pin down with a small screwdriver. This ensures that the unit is properly locked and will not accidentally come out from the dashboard. Install the Detachable Front Panel.

### Removal

- 1 Remove the DETACHABLE FRONT PANEL.
- 2 Use a small screwdriver (or similar tool) to push the locking pins to the "up" position (see above drawing). As each pin is unlocked, gently pull out on the unit to make sure it does not re-lock before unlocking the second pin.
- 3 Pull the unit out, keeping it unlocked as you do so.

### <JAPANESE CAR>

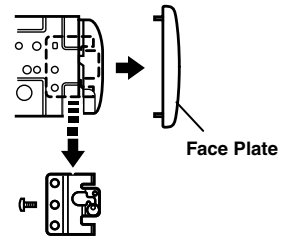

CDA-7995/  
CDA-7894/  
CDA-7893/  
CDA-7892

Screws (M5 × 8)  
(Included)

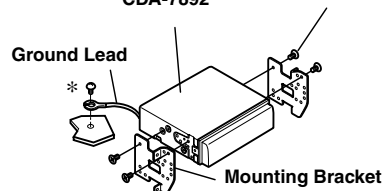

### NOTE

Secure the ground lead of the unit to a clean metal spot using a screw (\*) already attached to the vehicle's chassis.

# Installation and Connections

## Connections

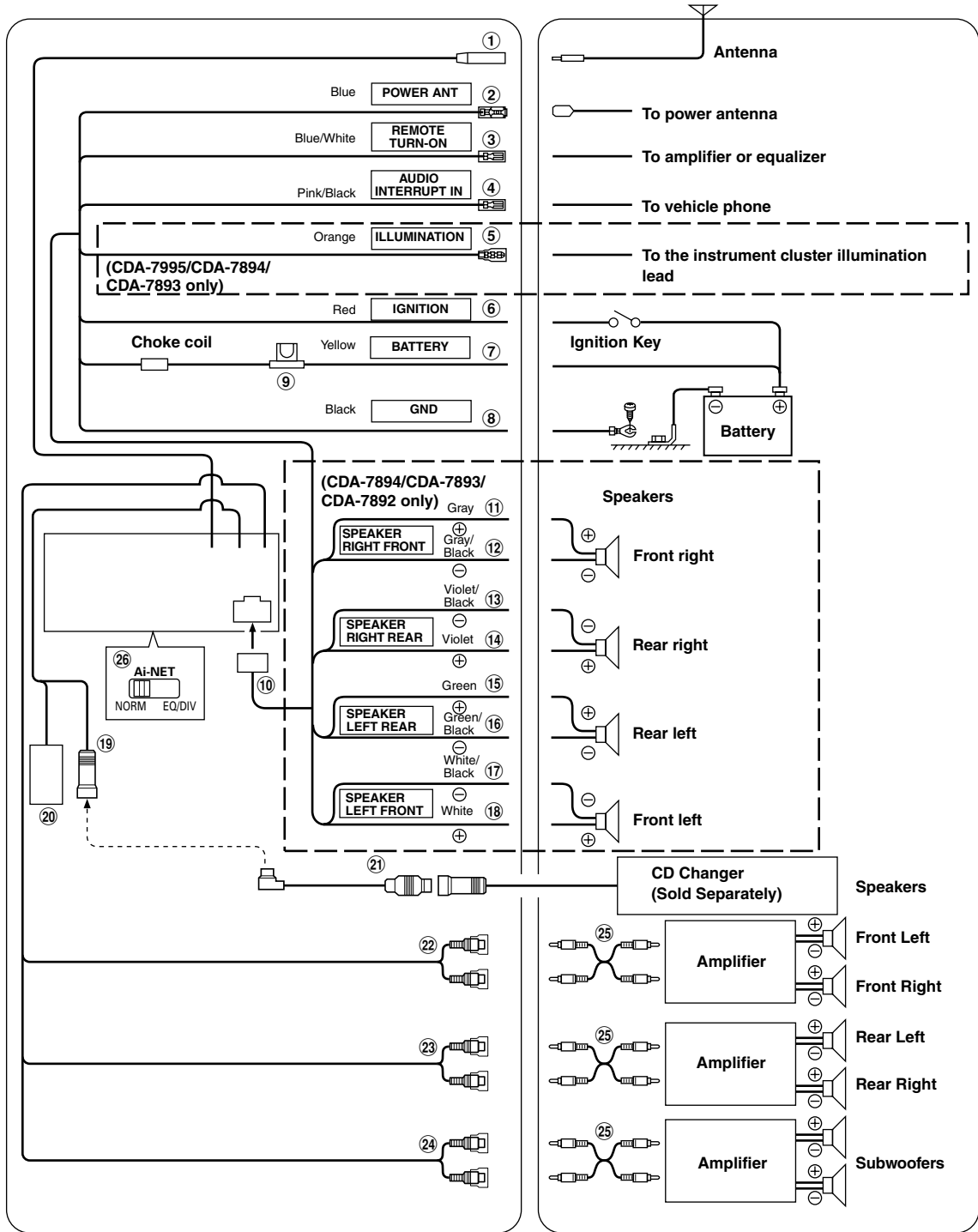



- ① Antenna Receptacle
- ② Power Antenna Lead (Blue)  
Connect this lead to the +B terminal of your power antenna, if applicable.  
**NOTE**  
*This lead should be used only for controlling the vehicle's power antenna. Do not use this lead to turn on an amplifier or a signal processor, etc.*
- ③ Remote Turn-On Lead (Blue/White)  
Connect this lead to the remote turn-on lead of your amplifier or signal processor.
- ④ Audio Interrupt In Lead (Pink/Black)
- ⑤ Illumination Lead (Orange)  
This lead may be connected to the vehicle's instrument cluster illumination lead. This will allow the backlighting of the CDA-7995/CDA-7894/CDA-7893 to dim whenever the vehicle's lights are turned on.
- ⑥ Switched Power Lead (Ignition) (Red)  
Connect this lead to an open terminal on the vehicle's fuse box or another unused power source which provides (+)12V only when the ignition is turned on or in the accessory position.
- ⑦ Battery Lead (Yellow)  
Connect this lead to the positive (+) post of the vehicle's battery.  
**NOTE (CDA-7894/CDA-7893 only)**  
*Use an extension battery lead (20A)(sold separately) and connect it directly to the positive (+) side of the vehicle's battery.*
- ⑧ Ground Lead (Black)  
Connect this lead to a good chassis ground on the vehicle. Make sure the connection is made to bare metal and is securely fastened using the sheet metal screw provided.
- ⑨ Fuse Holder  
(5A ..... CDA-7995 only)  
(15A ..... CDA-7892 only)  
(20A ..... CDA-7894/CDA-7893 only)
- ⑩ Power Supply Connector
- ⑪ Right Front (+) Speaker Output Lead (Gray) (CDA-7894/CDA-7893/CDA-7892 only)
- ⑫ Right Front (-) Speaker Output Lead (Gray/Black) (CDA-7894/CDA-7893/CDA-7892 only)
- ⑬ Right Rear (-) Speaker Output Lead (Violet/Black) (CDA-7894/CDA-7893/CDA-7892 only)
- ⑭ Right Rear (+) Speaker Output Lead (Violet) (CDA-7894/CDA-7893/CDA-7892 only)
- ⑮ Left Rear (+) Speaker Output Lead (Green) (CDA-7894/CDA-7893/CDA-7892 only)
- ⑯ Left Rear (-) Speaker Output Lead (Green/Black) (CDA-7894/CDA-7893/CDA-7892 only)
- ⑰ Left Front (-) Speaker Output Lead (White/Black) (CDA-7894/CDA-7893/CDA-7892 only)
- ⑱ Left Front (+) Speaker Output Lead (White) (CDA-7894/CDA-7893/CDA-7892 only)
- ⑲ Ai-NET Connector  
Connect this to the output or input connector of other product (CD Changer, Equalizer, etc.) equipped with Ai-NET.  
**NOTE**  
*You can input TV/video sound by connecting an optional Ai-NET/RCA Interface cable (KCA-121B) to this component.*
- ⑳ DC/DC Converter (CDA-7995/CDA-7894 only)  
**NOTES**
  - Do not install the converter at a location subjected to water such as under the floor mat or air conditioner. This may cause a malfunction.
  - Do not bundle the DC/DC converter cable with other audio cables. Doing so may induce noise into your system.
  - Keep the DC/DC converter away from the Antenna cables and the rear side of the unit, otherwise noise may be generated when receiving radio broadcast.
- ㉑ Ai-NET Cable (Included with CD Changer)
- ㉒ Front Output RCA Connectors
- ㉓ Rear Output RCA Connectors  
RED is right and WHITE is left.
- ㉔ Subwoofer RCA Connectors  
RED is right and WHITE is left.
- ㉕ RCA Extension Cable (Sold Separately)
- ㉖ System Switch  
When connecting a processor or divider using Ai-NET, place this switch in the EQ/DIV position. When no device is connected, leave the switch in the NORM position.  
**NOTE**  
*Be sure to turn the power off to the unit before changing the switch position.*

**To prevent external noise from entering the audio system.**

- Locate the unit and route the leads at least 10 cm away from the car harness.
- Keep the battery power leads as far away from other leads as possible.
- Connect the ground lead securely to a bare metal spot (remove any paint, dirt or grease if necessary) of the car chassis.
- If you add an optional noise suppressor, connect it as far away from the unit as possible. Your Alpine dealer carries various noise suppressors, contact them for further information.
- Your Alpine dealer knows best about noise prevention measures so consult your dealer for further information.



# LIMITED WARRANTY

ALPINE ELECTRONICS OF AMERICA, INC. AND ALPINE OF CANADA INC. ("Alpine"), are dedicated to quality craftsmanship and are pleased to offer this Warranty. We suggest that you read it thoroughly. Should you have any questions, please contact your Dealer or Alpine at one of the telephone numbers listed below.

## ● PRODUCTS COVERED:

This Warranty covers Car Audio/Visual Products and Related Accessories ("the product"). Products purchased in the Canada are covered only in the Canada. Products purchased in the U.S.A. are covered only in the U.S.A.

## ● LENGTH OF WARRANTY:

This Warranty is in effect for one year from the date of the first consumer purchase.

## ● LIFETIME TAPE HEAD WARRANTY:

All Alpine Car Audio analog tape heads excluding Video tape heads are warranted for life against manufacturing defects causing failure.

## ● WHO IS COVERED:

This Warranty only covers the original purchaser of the product, who must reside in the United States, Puerto Rico or Canada.

## ● WHAT IS COVERED:

This Warranty covers defects in materials or workmanship (parts and labor) in the product.

## ● WHAT IS NOT COVERED:

This Warranty does not cover the following:

- ① Damage occurring during shipment of the product to Alpine for repair (claims must be presented to the carrier).
- ② Damage caused by accident, abuse, negligence, misuse, improper connections, improper operation or failure to follow instructions contained in the Owner's manual.
- ③ Damage caused by act of God, including without limitation, earthquake, fire, flood, storms or other acts of nature.
- ④ Any cost or expense related to the removal or reinstallation of the product.
- ⑤ Service performed by an unauthorized person, company or association.
- ⑥ Any product which has the serial number defaced, altered or removed.
- ⑦ Any product which has been adjusted, altered or modified without Alpine's consent.
- ⑧ Any product not distributed by Alpine within the United States, Puerto Rico or Canada.
- ⑨ Any product not purchased from an Authorized Alpine Dealer.
- ⑩ Any product that has been determined to contain an excessive amount of dust or dirt and any product that contains other contaminants including liquid or foreign objects.

## ● HOW TO OBTAIN WARRANTY SERVICE:

- ① You are responsible for delivery of the product to an Authorized Alpine Service Center or Alpine for repair and for payment of any initial shipping charges. Alpine will, at its option, repair or replace the product with a new or reconditioned product without charge. If the repairs are covered by the warranty, and if the product was shipped to an Authorized Alpine Service Center or Alpine, Alpine will pay the return shipping charges.

- ② You should provide a detailed description of the problem(s) for which service is required.
- ③ You must supply proof of your purchase of the product.
- ④ You must package the product securely to avoid damage during shipment.

## ● HOW WE LIMIT IMPLIED WARRANTIES:

ANY IMPLIED WARRANTIES INCLUDING FITNESS FOR USE AND MERCHANTABILITY ARE LIMITED IN DURATION TO THE PERIOD OF THE EXPRESS WARRANTY SET FORTH ABOVE AND NO PERSON IS AUTHORIZED TO ASSUME FOR ALPINE ANY OTHER LIABILITY IN CONNECTION WITH THE SALE OF THE PRODUCT.

## ● HOW WE EXCLUDE CERTAIN DAMAGES:

ALPINE EXPRESSLY DISCLAIMS LIABILITY FOR INCIDENTAL AND CONSEQUENTIAL DAMAGES CAUSED BY THE PRODUCT. THE TERM "INCIDENTAL DAMAGES" REFERS TO EXPENSES OF TRANSPORTING THE PRODUCT TO THE ALPINE SERVICE CENTER, LOSS OF THE ORIGINAL PURCHASER'S TIME, LOSS OF THE USE OF THE PRODUCT, BUS FARES, CAR RENTALS OR OTHERS COSTS RELATING TO THE CARE AND CUSTODY OF THE PRODUCT. THE TERM "CONSEQUENTIAL DAMAGES" REFERS TO THE COST OF REPAIRING OR REPLACING OTHER PROPERTY WHICH IS DAMAGED WHEN THIS PRODUCT DOES NOT WORK PROPERLY. THE REMEDIES PROVIDED UNDER THIS WARRANTY ARE EXCLUSIVE AND IN LIEU OF ALL OTHERS.

## ● HOW STATE/PROVINCIAL LAW RELATES TO THE WARRANTY:

This Warranty gives you specific legal rights, and you may also have other rights which vary from state to state and province to province. In addition, some states/provinces do not allow limitations on how long an implied warranty lasts, and some do not allow the exclusion or limitation of incidental or consequential damages. Accordingly, limitations as to these matters contained herein may not apply to you.

## ● IN CANADA ONLY:

This Warranty is not valid unless your Alpine car audio product has been installed in your vehicle by an Authorized Installation Center, and this warranty stamped upon installation by the installation center.

## ● HOW TO CONTACT CUSTOMER SERVICE:

Should the product require service, please call the following number for your nearest Authorized Alpine Service Center.

<b>U.S.A.</b>	<b>1-800-ALPINE-1 (1-800-257-4631)</b>
<b>CANADA</b>	<b>1-800-ALPINE-1 (1-800-257-4631)</b>